



Submersible Sewage Pumps

# Cutter Impeller

## C/C(CR)





The C/C(CR) series incorporates a cutter mechanism consisting of one or two sintered tungsten carbide alloy edges integrated with a channel impeller and a suction cover with a saw-tooth suction port. The cutter mechanism cuts incoming fibrous materials into pieces, permitting smooth passage of them.



Cutter Pump Operation

### Motor Protector

Each pump up to 7.5kW as standard has a built in auto-cut, self-resetting Circle Thermal Protector (CTP). Integrated in the motor housing, the CTP directly cuts the motor circuit if excessive heat builds up or an overcurrent caused by an electrical or mechanical failure occurs.

A Miniature Thermal Protector (MTP) is embedded in each winding of the motor. These MTPs are connected in series, and their wires are led out of the motor. Should the winding temperature rise to the actuating temperature, the bimetal strip opens to cause the control panel to shut the power supply.

### Mechanical Seal

The mechanical seal with two seal faces containing silicon carbide (SiC) is equipped with the oil chamber. The advantages of the seal are two-fold, it eliminates spring failure caused by corrosion, abrasion or fouling which prevents the seal faces from closing properly, and prevents loss of cooling to the lower seal faces during run-dry conditions which causes the lower seal faces to fail.

### Oil Lifter (Patented)

The Oil Lifter was developed as a lubricating device for the mechanical seal. Utilizing the centrifugal force of the shaft seal, the Oil Lifter forcibly supplies lubricating oil to the mechanical seal and continues to supply the oil to the upper seal faces even if lubricant falls below the rated volume. This amazingly simple device is not only reliably lubricates and cools down, but also retains the stable shaft seal effect and extends the inspection term.

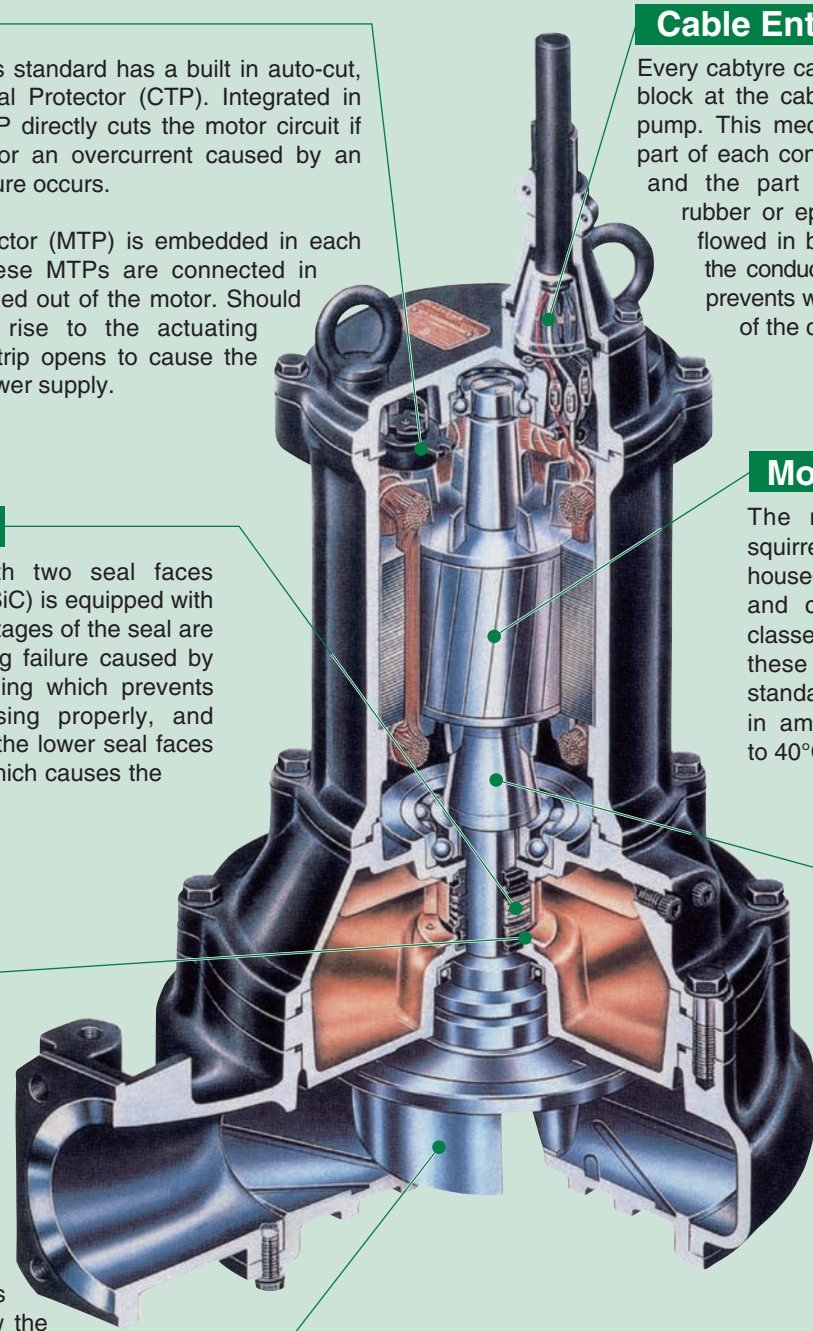

### Cable Entry

Every cable has an anti-wicking block at the cable entry section of the pump. This mechanism is such that a part of each conductor is stripped back and the part is sealed by molded rubber or epoxy potting which has flowed in between each strand of the conductor. This unique feature prevents wicking along the strands of the conductor itself.

### Motor

The motor is a dry-type, squirrel-cage induction motor, housed in a watertight casing, and conforms to insulation classes B, E or F. In each of these insulation classes, all standard pumps can be used in ambient temperatures up to 40°C.

### Shaft

The high-tensile stainless steel shaft used on all pumps is designed to have adequate strength for the transmission of the full load. It is supported by C3 type, high-quality, deep-groove ball bearings.

### Impeller & Suction Cover

One or two sintered tungsten carbide alloy edges are brazed onto the impeller vane, and they rotate on the serrated part of the suction cover. Incoming fibrous materials are cut up by this mechanism, and this prevents clogging in the pump discharge pipes or valves.

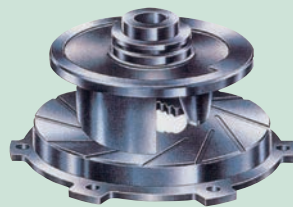

## AUTOMATIC MODEL

The Tsurumi automatic model has an integral control circuit and two float switches that operate at a low voltage. It operates automatically in response to the change in water levels. As the pump has a Circle Thermal Protector (CTP) integrated into the motor to protect the motor from overload or overheating, it is not required to provide an extra motor protection circuit in the starter panel.

This model can be identified by the suffix "A". Refer to model selection for availability and model numbers.



## GUIDE RAIL FITTING SYSTEM

### TOS and TO

The TOS/TO is the Tsurumi standard guide rail fitting system. This system connects the pump to and from the piping easily just by lowering and hoisting the pump, allowing easy maintenance and inspection without the need to enter the sump.



## AUTO-ALTERNATION MODEL

The auto-alternation model is used along with an automatic model. The combinational use of these two pumps enables each pump to operate alternately without control panel.

The auto-alternation model has three floats and can be identified by the suffix "W". Refer to model selection for availability and model numbers. It is available in the same output range of the automatic pumps.

### How the Auto-alternation Model Works

● Operation is enabled by merely connecting the power supply.

#### Primary Operation

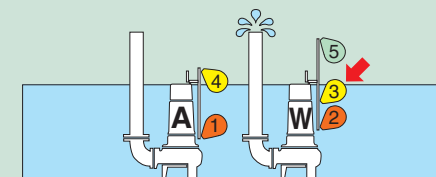

1 Float 3 operates, and pump W starts to discharge water.

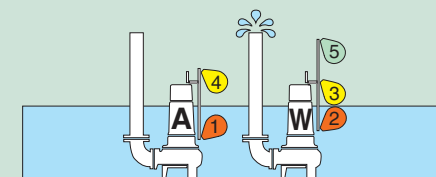

2 Water is discharged (water level falls).

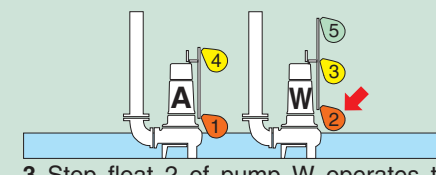

3 Stop float 2 of pump W operates to end water discharge. At this time, alternation start float 3 of pump W rests for one discharge operation.

#### Secondary Operation

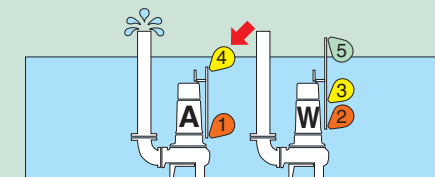

1 Start float 4 of pump A operates to start water discharge.

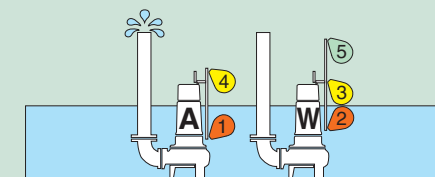

2 Water is discharged (water level falls).

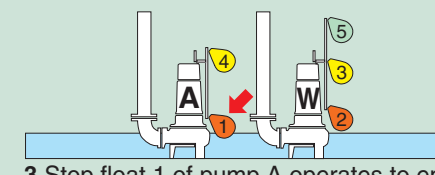

3 Stop float 1 of pump A operates to end water discharge. At the same time, start float 3 of pump W becomes ready for operation.

- ※ Primary and secondary operation are repeated alternately.
- ※ Both primary and secondary operations are performed simultaneously when water has risen to an abnormal level.

## MODEL NUMBER DESIGNATION

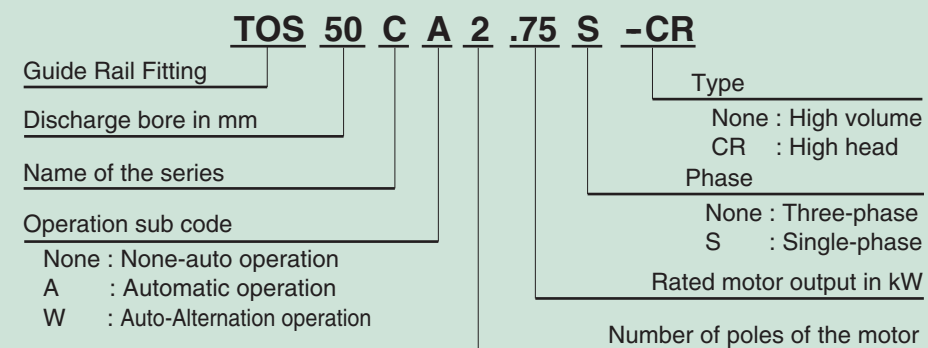

### Performance Curves

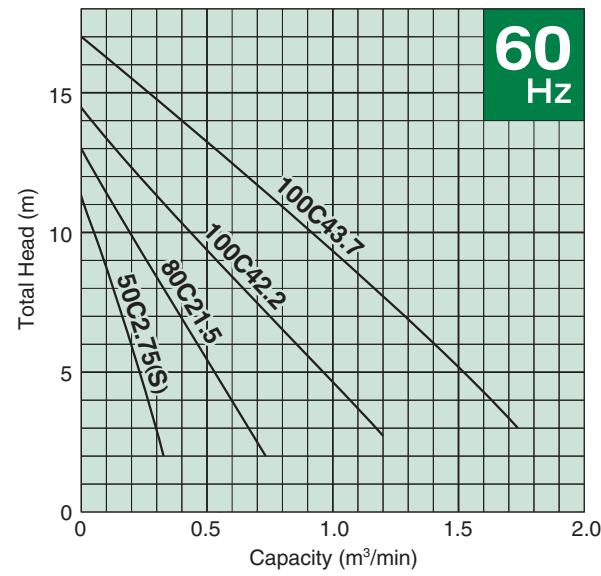
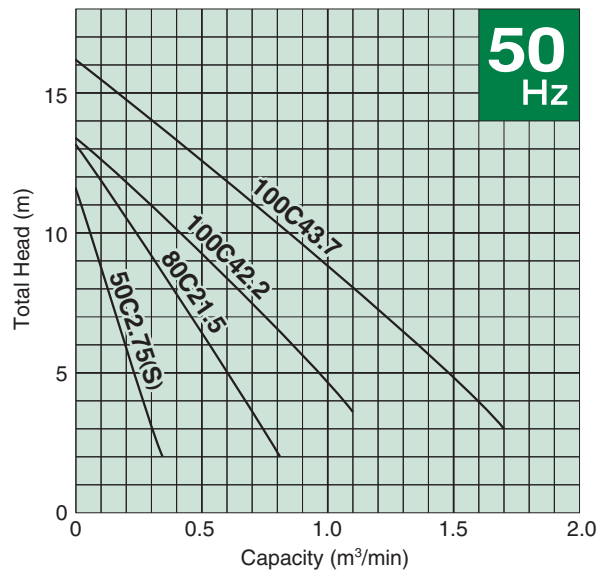

### Performance Curves

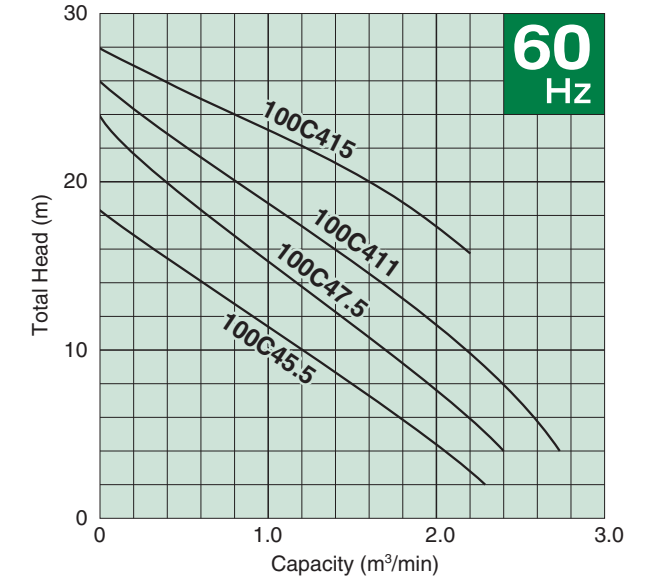
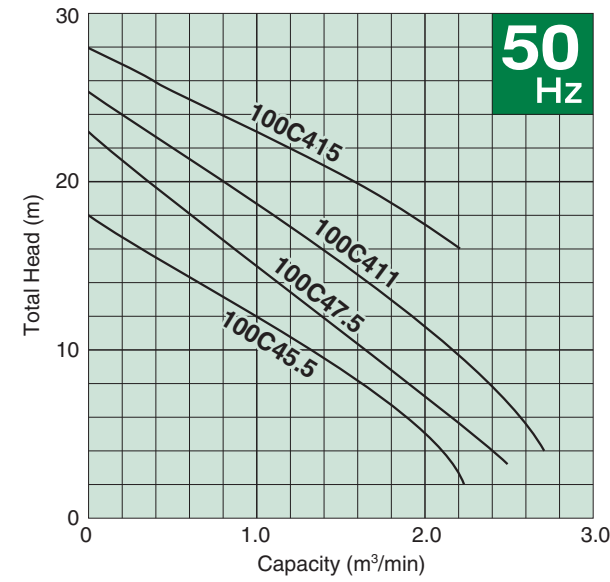

### Model Selection 50/60Hz

Discharge Bore mm	Standard Model		Automatic Model		Auto-Alternation Model		Motor Output kW	Phase	Speed (S.S.) min <sup>-1</sup>	Starting Method	Solids Passage mm	Cable Length m	Cable Code	Dimensions L x H mm				Dry Weight * <sup>4</sup> kg			
	Free Standing	Guide Rail Fitting	Free Standing	Guide Rail Fitting	Free Standing	Guide Rail Fitting								Standard Model		Auto&Auto-Alternation Model		Standard Model		Auto&Auto-Alternation Model	
														Free Standing	Guide Rail Fitting	Free Standing	Guide Rail Fitting	Free Standing	Guide Rail Fitting	Free Standing	Guide Rail Fitting
50	50C2.75S	TOS50C2.75S	50CA2.75S	TOS50CA2.75S	—	—	0.75	Single	3000/3600	Capacitor start	31 x 27/ 28 x 27	5	a(b* <sup>2</sup> )	405 x 523	621 x 566	405 x 580	621 x 624	32	30	34	32
50	50C2.75	TOS50C2.75	50CA2.75	TOS50CA2.75	50CW2.75	TOS50CW2.75	0.75	Three	3000/3600	D.O.L.	31 x 27/ 28 x 27	6	A	405 x 415	621 x 458	433 x 496	649 x 539	24	23	25	24
80	80C21.5	TOS80C21.5	80CA21.5	TOS80CA21.5	80CW21.5	TOS80CW21.5	1.5	Three	3000/3600	D.O.L.	43 x 60/ 37 x 60	6	A	446 x 536	668 x 586	485 x 630	707 x 680	36	34	40	38
100	100C42.2	TOS100C42.2	—	—	—	—	2.2	Three	1500/1800	D.O.L.	67 x 56/ 62 x 56	6	A(C* <sup>3</sup> )	596 x 641	754 x 656	—	—	68	64	—	—
100	100C43.7	TOS100C43.7	—	—	—	—	3.7	Three	1500/1800	D.O.L.	70 x 81/ 64 x 81	6	C(E* <sup>3</sup> )	601 x 715	759 x 725	—	—	84	80	—	—
100	100C45.5	TOS100C45.5	—	—	—	—	5.5	Three	1500/1800	D.O.L.* <sup>1</sup>	82 x 68/ 68 x 68	8	H	686 x 908	905 x 906	—	—	140	133	—	—
100	100C47.5	TOS100C47.5	—	—	—	—	7.5	Three	1500/1800	D.O.L.* <sup>1</sup>	76 x 69/ 71 x 68	8	I	686 x 929	905 x 927	—	—	159	152	—	—
100	100C411	TOS100C411	—	—	—	—	11	Three	1500/1800	Star-Delta	82 x 75/ 87 x 75	8	L	710 x 1000	928 x 998	—	—	184	177	—	—
100	100C415	TOS100C415	—	—	—	—	15	Three	1500/1800	Star-Delta	87 x 45/ 77 x 40	8	M	707 x 1080	926 x 1078	—	—	230	210	—	—

\*<sup>1</sup> Star-Delta available upon request

\*<sup>2</sup> 100-120V \*<sup>3</sup> 200-240V

\*<sup>4</sup> All weights excluding cable

Weights of guide rail fitting model excluding duckfoot bend

### Cable Code Reference

#### Single-Phase

Code	No. of Cables	Cores x mm <sup>2</sup>	Dia. mm	Material
a	1	3 x 1.25	10.1	PVC
b	1	3 x 2	10.9	

#### Three-Phase

Code	No. of Cables	Cores x mm <sup>2</sup>	Dia. mm	Material
A	1	4 x 1.25	11.1	PVC
C	1	4 x 2	11.8	
E	1	4 x 3.5	13.9	

#### Three-Phase

Code	No. of Cables	Cores x mm <sup>2</sup>	Dia. mm	Material
H	1	4 x 3.5	14.1	Chloroprene Rubber
I	1	4 x 5.5	16.8	
L	3	4 x 3.5	14.1	
		3 x 3.5	12.9	
		2 x 1.25	9.8	
M	3	4 x 5.5	16.8	
		3 x 5.5	15.2	
		2 x 1.25	9.8	

### Dimensions

Free Standing

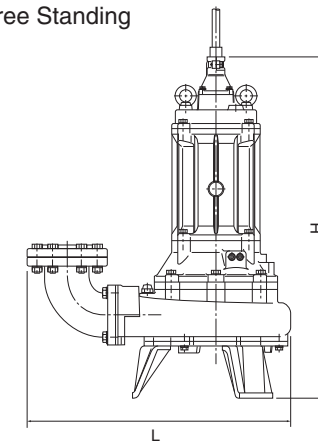

Guide Rail Fitting

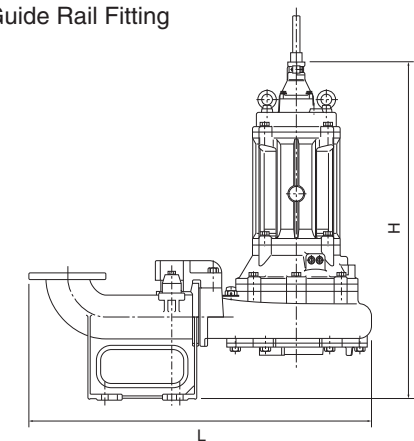



### Performance Curves

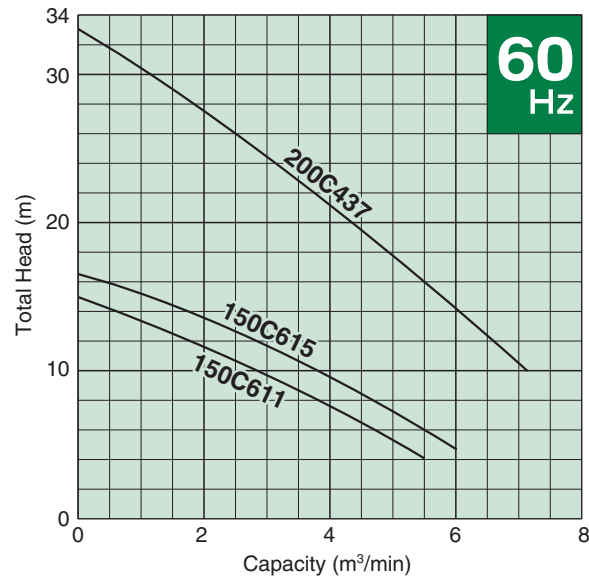
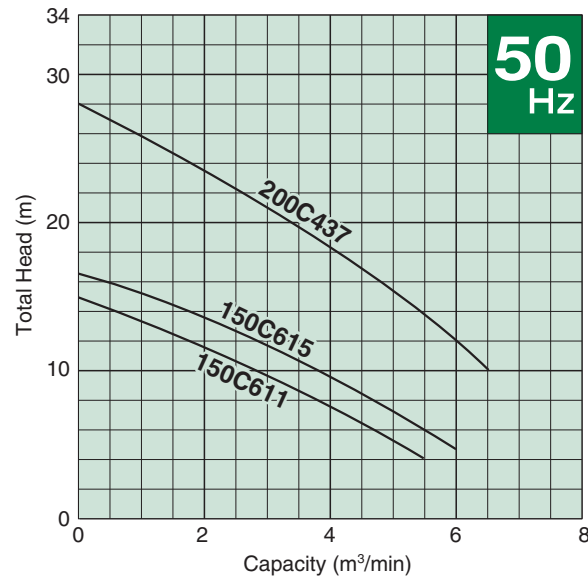

### Model Selection 50/60Hz

Discharge Bore mm	Model		Motor Output kW	Phase	Speed (S.S.) min <sup>-1</sup>	Starting Method	Solids Passage mm	Cable Length m	Cable Code	Dimensions L x H mm		Dry Weight* <sup>2</sup> kg	
	Free Standing	Guide Rail Fitting								Free Standing	Guide Rail Fitting	Free Standing	Guide Rail Fitting
150	150C611	TOS150C611	11	Three	1000/1200	Star-Delta	100 x 70	8	P(Q* <sup>1</sup> )	1043 x 1211	1237 x 1126	430	390
150	150C615	TOS150C615	15	Three	1000/1200	Star-Delta	100 x 70	8	Q(R* <sup>1</sup> )	1043 x 1261	1228 x 1176	500	410
200	200C437	TO200C437	37	Three	1500/1800	Star-Delta	76 x 73	10	S	1190 x 1588	1428 x 1408	660	555

\*1 200-240V

\*2 All weights excluding cable  
Weights of guide rail fitting excluding duckfoot bend

### Cable Code Reference

Code	No. of Cables	Cores x mm <sup>2</sup>	Dia. mm	Material
C	1	4 x 2	11.8	PVC
E	1	4 x 3.5	13.9	
H	1	4 x 3.5	14.1	
I	1	4 x 5.5	16.8	
L	3	4 x 3.5	14.1	Chloroprene Rubber
		3 x 3.5	12.9	
		2 x 1.25	9.8	
M	3	4 x 5.5	16.8	Chloroprene Rubber
		3 x 5.5	15.2	
		2 x 1.25	9.8	
N	3	4 x 14	21.7	Chloroprene Rubber
		3 x 14	19.7	
		4 x 1.25	9.6	PVC
P	1	7 x 3.5 2 x 2	21.3	Chloroprene Rubber
Q	1	7 x 5.5 2 x 2	24.4	
R	1	7 x 8 2 x 2	25.6	
S	3	4 x 22	28.8	Chloroprene Rubber
		3 x 22	26.1	
		4 x 1.25	9.6	PVC

### Dimensions

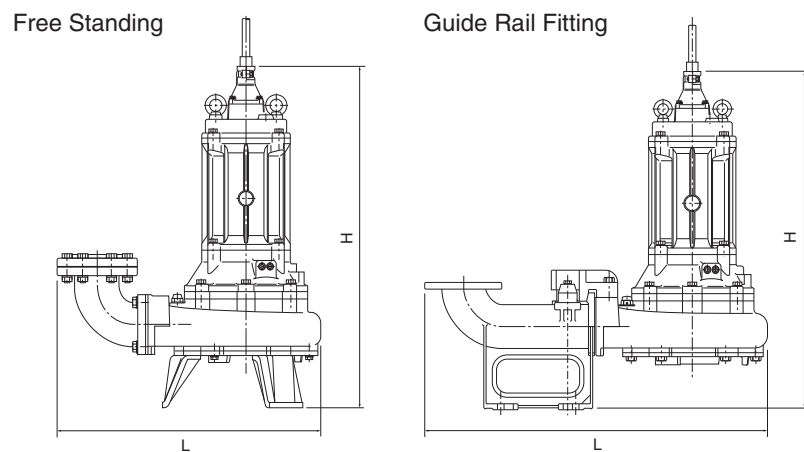

### Performance Curves

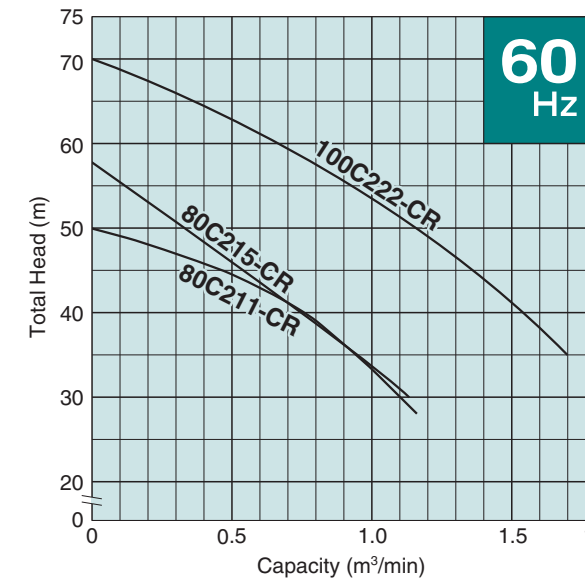
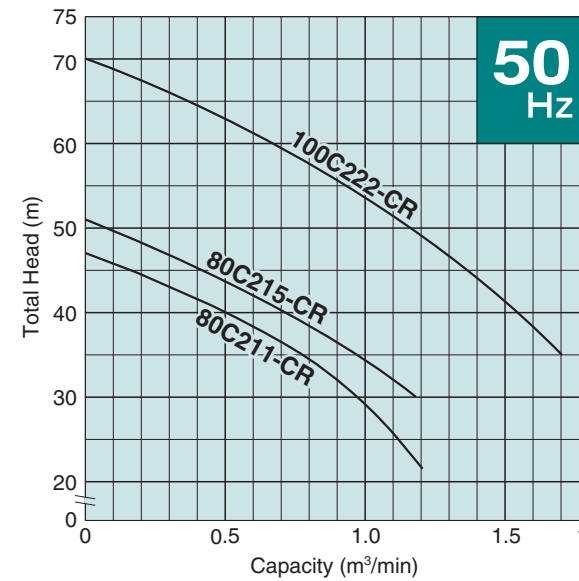
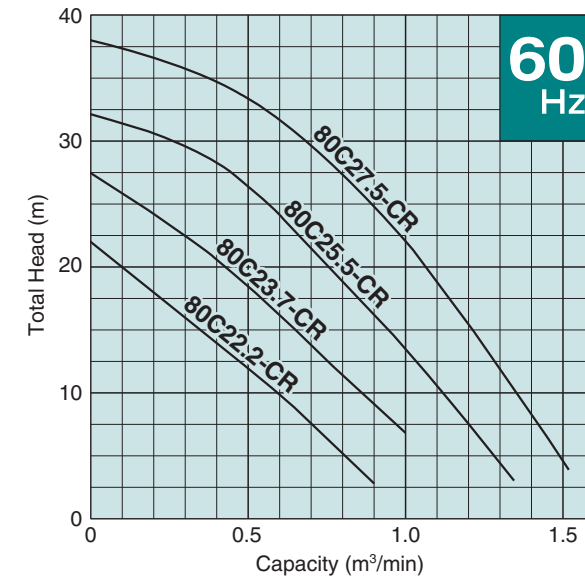
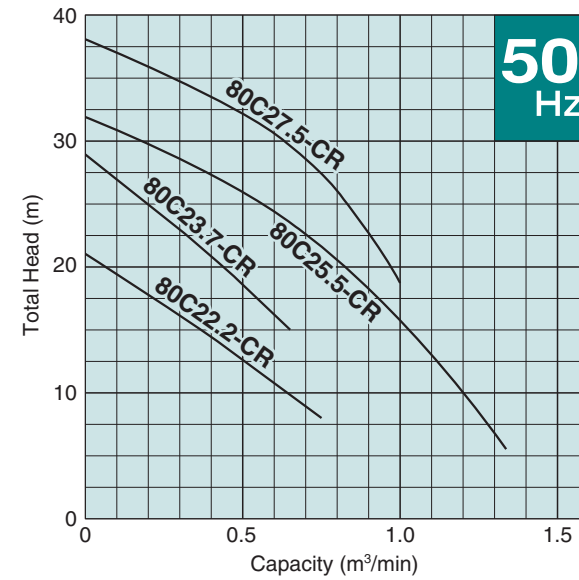

### Model Selection 50/60Hz

Discharge Bore mm	Model		Motor Output kW	Phase	Speed (S.S.) min <sup>-1</sup>	Starting Method	Solids Passage mm	Cable Length m	Cable Code	Dimensions L x H mm		Dry Weight* <sup>3</sup> kg	
	Free Standing	Guide Rail Fitting								Free Standing	Guide Rail Fitting	Free Standing	Guide Rail Fitting
80	80C22.2-CR	TOS80C22.2-CR	2.2	Three	3000/3600	D.O.L.	22 x 31/ 20 x 31	10	C	519 x 611	693 x 640	77	68
80	80C23.7-CR	TOS80C23.7-CR	3.7	Three	3000/3600	D.O.L.	22 x 31.3/ 22 x 31	10	C(E* <sup>2</sup> )	519 x 613	693 x 640	80	71
80	80C25.5-CR	TOS80C25.5-CR	5.5	Three	3000/3600	D.O.L.* <sup>1</sup>	29 x 23.2/ 29 x 23	10	H	615 x 879	788 x 877	136.5	123
80	80C27.5-CR	TOS80C27.5-CR	7.5	Three	3000/3600	D.O.L.* <sup>1</sup>	26 x 25.5/ 29 x 23	10	I	615 x 879	788 x 877	141.5	128
80	80C211-CR	TOS80C211-CR	11	Three	3000/3600	Star-Delta	26 x 26.7/ 26 x 25.5	10	L	615 x 927	788 x 925	156.5	143
80	80C215-CR	TOS80C215-CR	15	Three	3000/3600	Star-Delta	26 x 25.5	10	L(M* <sup>2</sup> )	730 x 1086	937 x 1086	260	235
100	100C222-CR	TOS100C222-CR	22	Three	3000/3600	Star-Delta	26 x 30	10	N	837 x 1184	1025 x 1184	420	380

\*1 Star-Delta available upon request \*2 200-240V

\*3 All weights excluding cable  
Weights of guide rail fitting excluding duckfoot bend

## SPECIAL ACCESSORIES

### FLOAT SWITCHES

Tsurumi offers two types of float switches (liquid level sensors). A micro-switch is incorporated in both types.

Model MC-2 is a heavy-duty type float switch with a shock absorber. Having equipped with a high grade micro switch, the MC-2 assures trouble-free operation in the liquid containing much suspended solids and floating scum. Either of the two contacts, normally-open or normally-close, can be selected as required.



Model RF-5 is an economy type float which can detect upper/lower limit water levels with single float. The snap on-off action ensures stable operation in clean or waste water containing suspended solids or oil and fat.



## TSURUMI OPTIONS

### SPECIAL VERSION WITH GALVANIC CORROSION PROTECTION

In seawater, a material's resistance to corrosion can be seen clearly. When metals with different potentials are brought into contact in seawater, only the metal of lower potential corrodes. As the difference in potential increases, the metal of lower potential corrodes faster. As an option, Tsurumi can supply pumps with parts made of higher electric potential metal as the sacrificial anode.

### SPECIAL VERSION FOR HIGHER TEMPERATURE LIQUID

Standard pumps are designed for continuous running at the maximum ambient temperature of 40°C. In addition to these, Tsurumi can provide pumps for operation at higher liquid temperatures upon request. Refitting for operation at higher temperatures involves modification of not only the insulation of motor windings but also several components.

Two high-temperature operating models are available - the Rank 60 for operation in liquids up to 60°C and the Rank 90 for operation in liquids up to 90°C. Consult your dealer for more details. (These special versions are not available for some pump models.)

### DRY PIT VERSION

The advantage of dry pit model is that it will not be damaged by flooding, as it is constructed with a submersible pump. Tsurumi can provide the dry pit model as option. The water jacket covers whole part of the motor. It efficiently cools the motor for continuous operations.

### SPECIAL VERSION WITH NON-STANDARD MATERIALS

Tsurumi can also provide you with pumps with essential components such as the impeller, pump casing, and the suction cover made of non-standard materials. Select from stainless steel, chromium iron and bronze to suit your specific requirements. Consult your dealer for more details.

We reserve the right to change the specifications and designs for improvement without prior notice.

**TSURUMI**  
**MANUFACTURING CO., LTD.**  
www.tsurumi-global.com

Your Dealer