



TSURUMI PUMP

Submersible Resin Pumps

VANCS

PU/PN/PSF/PLS/TM/OM



Printed on recycled paper with soy ink -
Evidence of our commitment to the environment

Amenics
Amenities from Technology
for People and the Earth

Enriched Lineup: 0.15-3.7kW

Applicable to a Wide Variety of Applications



SELECTION TABLE

Category	Series	Discharge Bore mm	Impeller	Model	Motor Output kW						
					0.15	0.25	0.4	0.75	1.5	2.2	3.7
Sewage	PU	40 - 80	Vortex	Standard	[Progressive bar chart showing availability from 0.15 to 3.7 kW]						
				Automatic	[Progressive bar chart showing availability from 0.15 to 3.7 kW]						
				Auto-alternation	[Progressive bar chart showing availability from 0.15 to 3.7 kW]						
Wastewater	PN	40 - 80	Vortex	Standard	[Progressive bar chart showing availability from 0.25 to 3.7 kW]						
				Automatic	[Progressive bar chart showing availability from 0.25 to 3.7 kW]						
				Auto-alternation	[Progressive bar chart showing availability from 0.25 to 3.7 kW]						
Wastewater -High Head-	PSF	40 - 65	Closed	Standard	[Progressive bar chart showing availability from 0.25 to 3.7 kW]						
				Automatic	[Progressive bar chart showing availability from 0.25 to 3.7 kW]						
				Auto-alternation	[Progressive bar chart showing availability from 0.25 to 3.7 kW]						
Wastewater -Horizontal-	PLS	50	Vortex	Standard	[Progressive bar chart showing availability from 0.25 to 3.7 kW]						
Seawater	TM	40 - 80	Vortex	Standard	[Progressive bar chart showing availability from 0.25 to 3.7 kW]						
				Automatic	[Progressive bar chart showing availability from 0.25 to 3.7 kW]						
Wastewater -Economic-	OM	32	Vortex	Standard	[Progressive bar chart showing availability from 0.15 to 3.7 kW]						
				Automatic	[Progressive bar chart showing availability from 0.15 to 3.7 kW]						

TYPE OF IMPELLER

Vortex

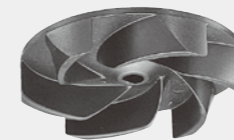

The vortex impeller is adopted in every series except for the PSF-series. Rotation of the impeller produces a whirling, centrifugal action between the impeller and the pump casing, and it moves the fluid through the pump. Being coupled with a wide pump casing, wastewater containing solid matters can be pumped out without obstruction.

Closed



The closed impeller is adopted in the PSF-series. The impeller is also referred to as shrouded impeller, as it has circular shrouds at both sides of the impeller vanes. Although the pump has a limited solids passage capability, it can be used for higher pumping head applications.

MODEL NUMBER DESIGNATION

40 PU A 2 .15 S

Discharge bore in millimeters

Name of the series

Operation sub code

None : None automatic operation

A : Automatic operation

W : Auto-alternation operation

Phase

None : Three-phase

S : Single-phase

Rated motor output in kilowatts

Number of poles of the motor

Practical Design Providing Excellent Corrosion Resistance and Durability

1. Anti-wicking Cable Entry

Every cabtyre cable has an anti-wicking block at the cable entry section on the pump. This mechanism is such that a part of each conductor is stripped back and the part is sealed by molded rubber or epoxy potting which has flowed in between each strand of the conductor. This unique feature prevents wicking along the strand of the conductor itself.

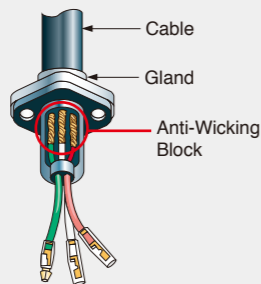

2. Motor Protector

A built-in thermal motor protection device reacts to the excessive heat caused by overcurrent or run-dry conditions. It not only cuts off the motor circuit automatically but also resets by itself. When the motor cools down to a safe operating temperature, the motor restarts.



3. Bearings

High-grade bearings for high-temperature operation are used. Also, as deep-groove, double-shielded C3 ball bearings are used, and as the bearings are permanently lubricated by grease, there is no need for injection of lubricating oil.

5. Dual Inside Mechanical Seal

A mechanical seal with two seal faces containing silicon carbide (SiC) is equipped with the oil chamber. The advantages of the seal are two-fold, it eliminates spring failure caused by corrosion, abrasion or fouling which prevents the seal faces from closing properly, and prevents loss of cooling to the lower seal faces during run-dry conditions which causes the lower seal faces to fail.

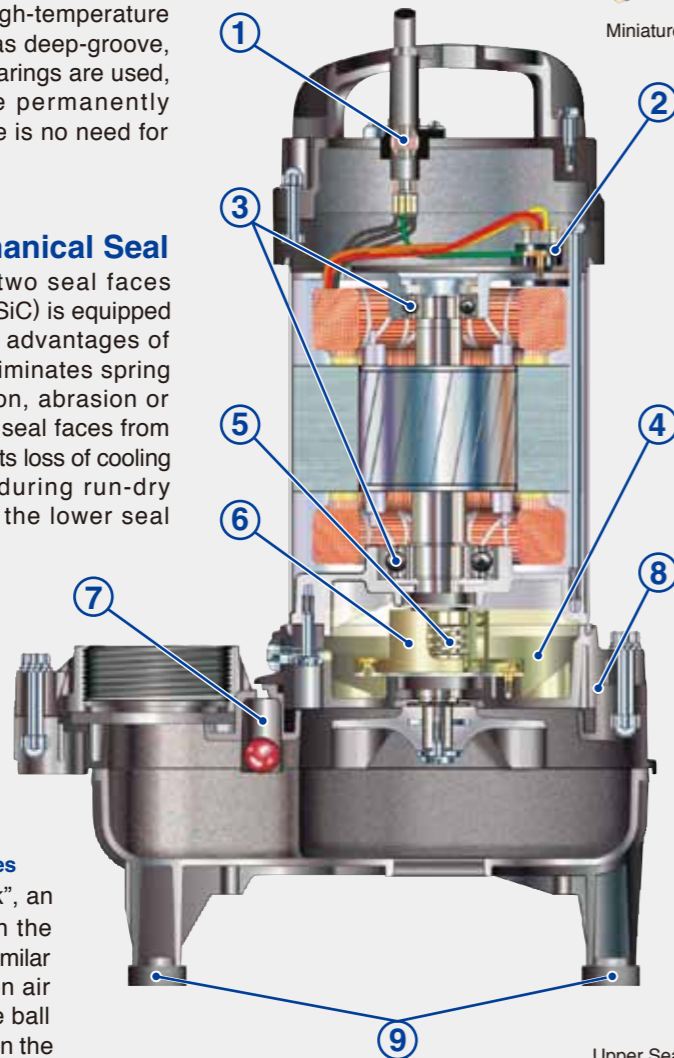

7. Air Release Valve

* Not Available for PLS-series

In order to prevent "air lock", an air release valve is built in the pump casing. The valve is similar to a ball check valve. When air goes through the valve, the ball stays at the bottom, but when the pumped water starts to flow, it closes the outlet by its buoyancy.



8. Back Pull-out Design

* Not Available for OM-series

Unfastening the bolts between the oil casing and the upper pump casing allows the body to be separated into the pump section and the motor section with the impeller left in position. This facilitates easier inspections of the main portions. The pump section can be disassembled/reassembled using a cross slot screwdriver (excluding 0.15kW).

4. Lubricating Oil

Liquid paraffin is used in every VANCS series pump. It is a highly-refined pure oil generally used in the industries of cosmetic, pharmaceutical, and food processing equipment, etc. The use of this oil widens the applications of the pumps to decorative waterfalls, fishponds, and aquaculture, etc.

6. Oil Lifter (Patented)

* Not Available for OM-series

The Oil Lifter was developed as a lubricating device for the mechanical seal. Utilizing the centrifugal force of the shaft seal, the Oil Lifter forcibly supplies lubricating oil to the mechanical seal and continues to supply the oil to the upper seal faces even if lubricant falls below the rated volume. This amazingly simple device is not only reliably lubricates and cools down, but also retains the stable shaft seal effect and extends the inspection term.

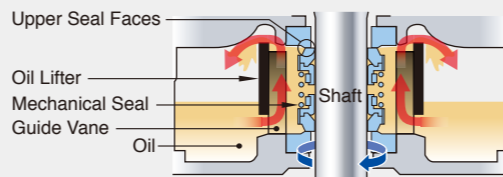

9. Rubber Foot

A rubber foot is fitted on each stand of the pumps from 1.5 to 3.7kW and the PLS-series pumps. This prevents scratching of floor surface.

TOK GUIDE RAIL FITTING SYSTEM

The TOK guide rail fitting system connects the pump to and from the piping easily just by lowering and hoisting the pump, allowing easy maintenance and inspection without the need to enter the sump.

Made of high-quality resin, the TOK is designed for lightweight, small to middle sized pumps. Rubber bellows attached to the guide hook are inverted to the duckfoot bend when the pump starts operating, and it seals by the pumping pressure. This eliminates leakage at the seal even if a lightweight pump is used in combination with the TOK.

The TOK is available in all motor output ranges of the PU, PN, and PSF series.

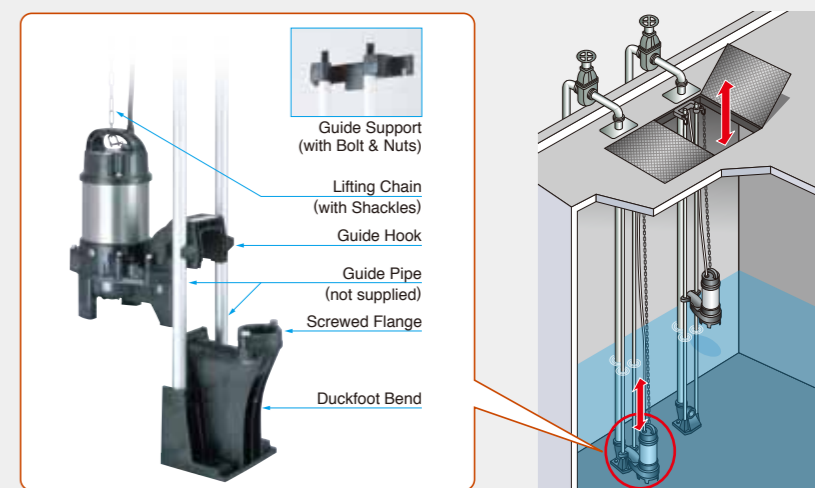

AUTOMATIC & AUTO-ALTERNATION MODEL

Automatic Model

The float type automatic model has an integral control circuit and two float switches that operate at a low voltage. It operates automatically in response to the change in water levels.

This model can be identified by the suffix "A" and is available in all motor output ranges of the PU, PN, PSF, and TM series.



The cylindrical float type automatic model is available only for the OM-series.

Adoption of the unique float switch has made even the automatic model very compact and enables it to be installed in a limited space. Automatic operation is possible with a simple power panel.



Auto-alternation Model

The auto-alternation model is used along with an automatic model. The combinational use of these two pumps enables each pump to operate alternately without control panel.

The auto-alternation model has three floats and can be identified by the suffix "W". Refer to model selection for availability and model numbers of the PU, PN, and PSF series.



How the Auto-alternation Model Works

Primary Operation

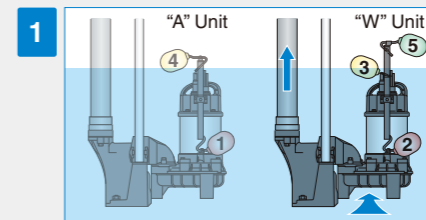

Water level rises and turns the Float #2 up. The Float #2 is activated but the pump does not start. When water level rises to Float #3 and the float is activated, the "W" unit starts.

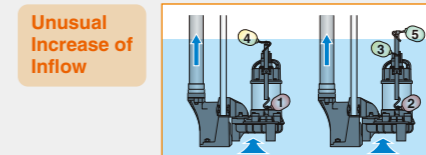

If inflow exceeds the capacity of "W" unit and the water level rises to Float #4, "A" unit starts.

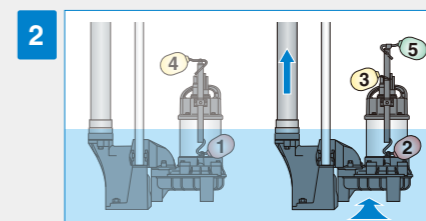

The "W" unit is discharging water (Water level falls).

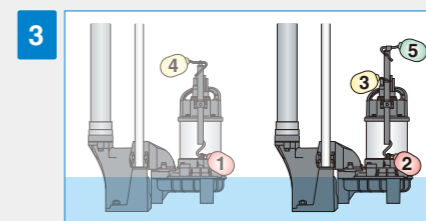

When water level falls to Float #2, the float is activated, and the "W" unit stops. The alternating circuitry deactivates the "W" unit for the next level rise.

Secondary Operation

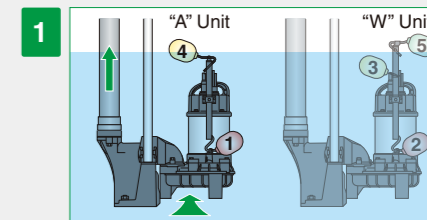

The next time the water level rises, Float #1 on the "A" unit is activated but the unit does not start until Float #4 is activated.

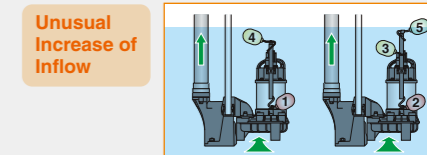

If inflow exceeds the capacity of "A" unit and the water level rises to Float #5, "W" unit starts.

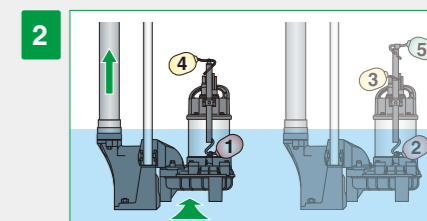

The "A" unit is discharging water (Water level falls).

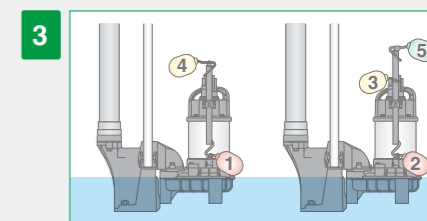

When water level falls and Float #1 is activated, the "A" unit stops. At the same time, "W" unit becomes ready for operation for the next level rise.

Submersible Sewage Pumps

PU

The PU-series is a vortex pump designed for handling raw sewage, wastewater, Industrial and commercial sump pump applications. The solid handling design provides practically unchokable operation in sewage pumping. Since the pump is made of special resin and stainless steel, it is corrosion-resistant and lightweight.



Major Components & Specifications

Discharge Bore	mm	40	50	80	
Pumping Fluid	Type of Fluid	Sewage, Wastewater, and Water carrying Solid Matters			
	Fluid Temperature	0 to 40°C			
Pump	Impeller	Vortex			
	Shaft Seal	Double Mechanical Seal (with Oil Lifter)			
	Bearing	Double-shielded Ball Bearing			
	Impeller	Glass-fiber Reinforced Resin			
	Casing	Glass-fiber Reinforced Resin			
Motor	Type, Pole	Dry-type Submersible Induction Motor, 2-pole			
	Insulation	Class E			
Motor	Phase	Single-phase (suffix "S") Three-phase			
	Starting Method	Capacitor Run (single-phase only) Direct on Line			
	Protection Device (Built-in)	Circle Thermal Protector Miniature Thermal Protector (40PU2.15S, 40PU2.25S & 50PU2.4S only)			
	Lubricant	Liquid Paraffin (ISO VG32)			
	Materials	Frame	304 Stainless Steel		
		Shaft	420 Stainless Steel (0.15kW only) 304 Stainless Steel		
Cable		PVC			
Discharge Connection	Screwed Flange				

Guide Rail Fitting

TOK Application Table

Model	Applicable Motor Output
TOK4-P	0.15 to 0.75kW
TOK2-65	1.5kW
TOK2-65T	2.2 to 3.7kW

Accessories

- Duckfoot Bend
- Guide Hook
- Guide Support with Bolts & Nuts
- Lifting Chain with Shackles (4m for TOK4-P, 5m for TOK2-65 / 65T)

Applications

- Draining sewage from factory, residence, hotel, restaurant, etc.
- Pumping rainwater and springwater at a place where foreign objects are likely to run into the water
- Transferring wastewater between the tanks at small-scale treatment facility

Cable Cables

Single-phase

Model	100-120V		200-240V		Length m	Material
	Cores x mm ²	Outer Dia. mm	Cores x mm ²	Outer Dia. mm		
40PU2.15S	3 x 1.25	10.1	3 x 1.25	10.1	5	PVC
40PU2.25S	3 x 1.25	10.1	3 x 1.25	10.1		
50PU2.4S	3 x 1.25	10.1	3 x 1.25	10.1		
50PU2.75S	3 x 2.0	10.9	3 x 1.25	10.1		

Three-phase

Model	200-240V		380-600V		Length m	Material
	Cores x mm ²	Outer Dia. mm	Cores x mm ²	Outer Dia. mm		
40PU2.15	4 x 1.25	11.1	4 x 1.25	11.1	6	PVC
40PU2.25	4 x 1.25	11.1	4 x 1.25	11.1		
50PU2.4	4 x 1.25	11.1	4 x 1.25	11.1		
50PU2.75	4 x 1.25	11.1	4 x 1.25	11.1		
80PU21.5	4 x 1.25	11.1	4 x 1.25	11.1		
80PU22.2	4 x 2.0	11.8	4 x 1.25	11.1		
80PU23.7	4 x 3.5	13.9	4 x 2.0	11.8		

Performance Curves

Standard, Automatic and Auto-alternation models have the identical performance.

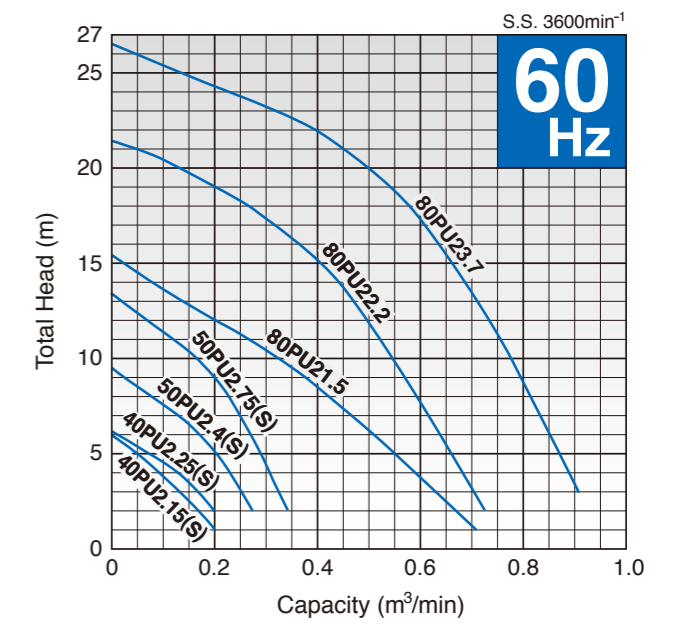
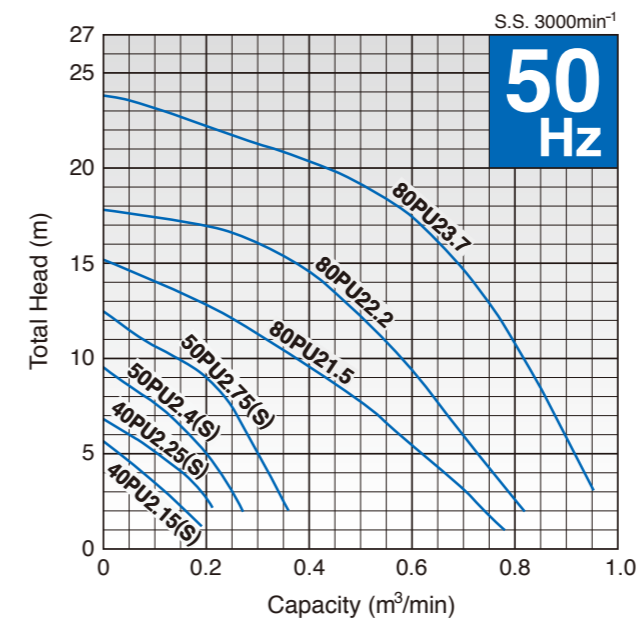

Model Selection

Discharge Bore mm	Model			Motor Output kW	Phase	Starting Method	Solids Passage mm	Dry Weight kg	
	Standard	Automatic	Auto-alternation					Standard	Auto & Auto-alternation
40	40PU2.15S	40PUA2.15S	40PUW2.15S	0.15	Single	Capacitor Run	35	6.1	6.7
40	40PU2.15	40PUA2.15	40PUW2.15	0.15	Three	D.O.L.	35	5.6	6.3
40	40PU2.25S	40PUA2.25S	40PUW2.25S	0.25	Single	Capacitor Run	35	7.1	7.8
40	40PU2.25	40PUA2.25	40PUW2.25	0.25	Three	D.O.L.	35	6.1	6.8
50	50PU2.4S	50PUA2.4S	50PUW2.4S	0.4	Single	Capacitor Run	35	7.1	7.8
50	50PU2.4	50PUA2.4	50PUW2.4	0.4	Three	D.O.L.	35	7.0	7.7
50	50PU2.75S	50PUA2.75S	—	0.75	Single	Capacitor Run	35	8.9	9.5
50	50PU2.75	50PUA2.75	50PUW2.75	0.75	Three	D.O.L.	35	8.3	9.0
80	80PU21.5	80PUA21.5	80PUW21.5	1.5	Three	D.O.L.	46	16.0	16.9
80	80PU22.2	80PUA22.2	80PUW22.2	2.2	Three	D.O.L.	46	22.0	23.0
80	80PU23.7	80PUA23.7	80PUW23.7	3.7	Three	D.O.L.	46	27.0	28.0

• Weights excluding cable

Dimensions

Model	d	A	B	H	Unit: mm	
					W1	W2
40PU2.15S	40	225	154	377	340	105
40PU2.15	40	225	154	377	340	105
40PU2.25S	40	236	162	360	325	110
40PU2.25	40	236	162	349	310	110
50PU2.4S	50	236	162	360	325	110
50PU2.4	50	236	162	360	325	110
50PU2.75S	50	236	162	380	345	110
50PU2.75	50	236	162	374	335	110
80PU21.5	80	295	196	475	430	150
80PU22.2	80	311	212	583	520	155
80PU23.7	80	311	212	618	555	155

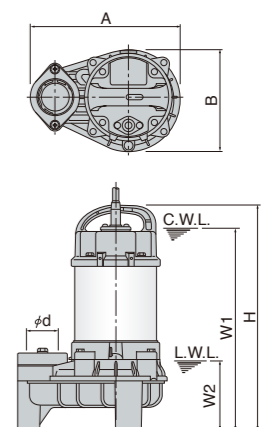

C.W.L.: Continuous Running Water Level
L.W.L.: Lowest Running Water Level

PN

The PN-series is a semi-vortex pump, which is constructed of a vortex impeller and low-height volute casing. The semi-vortex pump design with moderate solids passage provides efficient performance for versatile applications. Since the pump is made of special resin and stainless steel, it is corrosion-resistant and lightweight.



Major Components & Specifications

Discharge Bore	mm	40	50	80	
Pumping Fluid	Type of Fluid	Wastewater and Water carrying Small Solid Matters			
	Fluid Temperature	0 to 40°C			
Pump	Impeller	Vortex			
	Shaft Seal	Double Mechanical Seal (with Oil Lifter)			
	Bearing	Double-shielded Ball Bearing			
	Impeller	Glass-fiber Reinforced Resin			
	Casing	Glass-fiber Reinforced Resin			
Motor	Type, Pole	Dry-type Submersible Induction Motor, 2-pole			
	Insulation	Class E			
Motor	Phase	Single-phase (suffix "S") Three-phase			
	Starting Method	Capacitor Run (single-phase only) Direct on Line			
	Protection Device (Built-in)	Circle Thermal Protector Miniature Thermal Protector (40PN2.25S & 50PN2.4S only)			
	Lubricant	Liquid Paraffin (ISO VG32)			
	Materials	Frame	304 Stainless Steel		
		Shaft	304 Stainless Steel		
Cable		PVC			
Discharge Connection	Screwed Flange				

Guide Rail Fitting

TOK Application Table

Model	Applicable Motor Output
TOK4-P	0.25 to 0.75kW
TOK2-65	1.5kW
TOK2-65T	2.2 to 3.7kW

Accessories

- Duckfoot Bend
- Guide Hook
- Guide Support with Bolts & Nuts
- Lifting Chain with Shackles (4m for TOK4-P, 5m for TOK2-65 / 65T)

Applications

- Draining wastewater from residence, hotel, restaurant, etc.
- Pumping rainwater and springwater from basement
- Circulating water in waterscape garden (e.g. waterfall, fountain, koi pond, etc.)

Cable Cables

Single-phase

Model	100-120V		200-240V		Length m	Material
	Cores x mm ²	Outer Dia. mm	Cores x mm ²	Outer Dia. mm		
40PN2.25S	3 x 1.25	10.1	3 x 1.25	10.1	5	PVC
50PN2.4S	3 x 1.25	10.1	3 x 1.25	10.1		
50PN2.75S	3 x 2.0	10.9	3 x 1.25	10.1		

Three-phase

Model	200-240V		380-600V		Length m	Material
	Cores x mm ²	Outer Dia. mm	Cores x mm ²	Outer Dia. mm		
40PN2.25	4 x 1.25	11.1	4 x 1.25	11.1	6	PVC
50PN2.4	4 x 1.25	11.1	4 x 1.25	11.1		
50PN2.75	4 x 1.25	11.1	4 x 1.25	11.1		
50PN2.15	4 x 1.25	11.1	4 x 1.25	11.1		
80PN22.2	4 x 2.0	11.8	4 x 1.25	11.1		
80PN23.7	4 x 3.5	13.9	4 x 2.0	11.8		

Performance Curves

Standard, Automatic and Auto-alternation models have the identical performance.

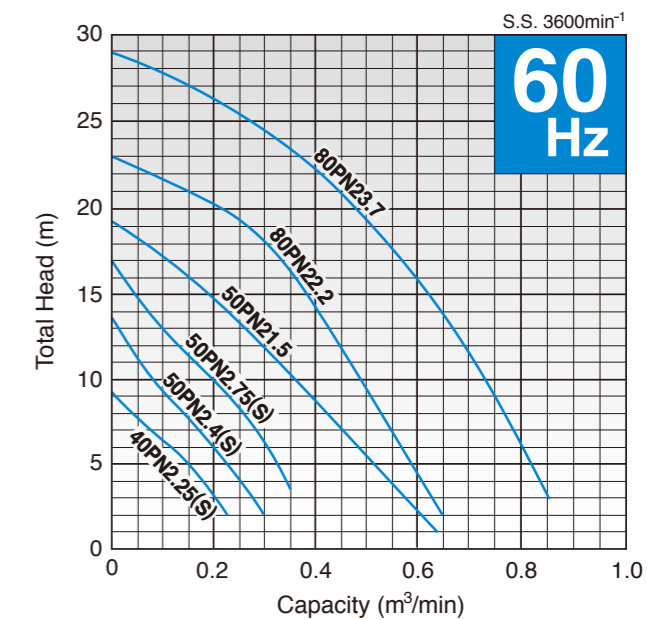
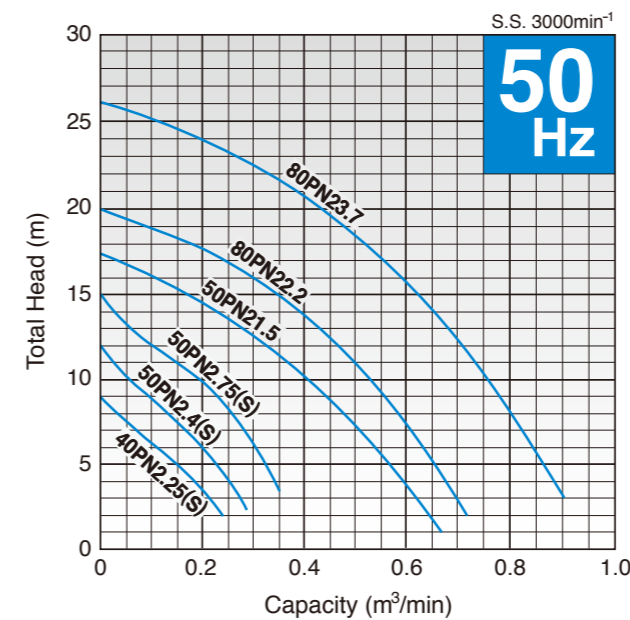

Model Selection

Discharge Bore mm	Model			Motor Output kW	Phase	Starting Method	Solids Passage mm	Dry Weight kg	
	Standard	Automatic	Auto-alternation					Standard	Auto & Auto-alternation
40	40PN2.25S	40PNA2.25S	40PNW2.25S	0.25	Single	Capacitor Run	10	7.1	7.8
40	40PN2.25	40PNA2.25	40PNW2.25	0.25	Three	D.O.L.	10	6.1	6.8
50	50PN2.4S	50PNA2.4S	50PNW2.4S	0.4	Single	Capacitor Run	10	7.1	7.8
50	50PN2.4	50PNA2.4	50PNW2.4	0.4	Three	D.O.L.	10	7.0	7.7
50	50PN2.75S	50PNA2.75S	—	0.75	Single	Capacitor Run	10	8.9	9.4
50	50PN2.75	50PNA2.75	50PNW2.75	0.75	Three	D.O.L.	10	8.3	9.0
50	50PN21.5	50PNA21.5	50PNW21.5	1.5	Three	D.O.L.	20	15.9	16.8
80	80PN22.2	80PNA22.2	80PNW22.2	2.2	Three	D.O.L.	20	22.0	23.0
80	80PN23.7	80PNA23.7	80PNW23.7	3.7	Three	D.O.L.	20	27.0	28.0

• Weights excluding cable

Dimensions

Model	d	A	B	H	W1	W2
40PN2.25S	40	236	162	360	325	110
40PN2.25	40	236	162	349	310	110
50PN2.4S	50	236	162	360	325	110
50PN2.4	50	236	162	360	325	110
50PN2.75S	50	236	162	380	345	110
50PN2.75	50	236	162	374	335	110
50PN21.5	50	295	196	435	390	110
80PN22.2	80	311	212	559	500	130
80PN23.7	80	311	212	594	535	130

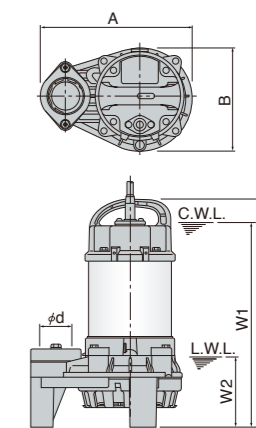

C.W.L.: Continuous Running Water Level
L.W.L.: Lowest Running Water Level

Submersible Wastewater Pumps — High Head —

PSF

The PSF-series incorporates a multi-vane, closed impeller and has the highest head characteristics in the VANCS-series. It is suitable for pumping screened liquids or liquids with no suspended solid. Since the pump is made of special resin and stainless steel, it is corrosion-resistant and lightweight.



Major Components & Specifications

Discharge Bore	mm	40	50	65
Pumping Fluid	Type of Fluid	Wastewater and Water carrying Few Solid Matters		
	Fluid Temperature	0 to 40°C		
Pump	Impeller	Closed		
	Shaft Seal	Double Mechanical Seal (with Oil Lifter)		
	Bearing	Double-shielded Ball Bearing		
	Impeller	Glass-fiber Reinforced Resin		
	Casing	Glass-fiber Reinforced Resin		
Motor	Type, Pole	Dry-type Submersible Induction Motor, 2-pole		
	Insulation	Class E		
Motor	Phase	Single-phase (suffix "S") Three-phase		
	Starting Method	Capacitor Run (single-phase only) Direct on Line		
	Protection Device (Built-in)	Circle Thermal Protector Miniature Thermal Protector (single-phase only)		
	Lubricant	Liquid Paraffin (ISO VG32)		
	Materials	Frame	304 Stainless Steel	
Discharge Connection	Shaft	304 Stainless Steel		
	Cable	PVC		
Discharge Connection	Screwed Flange			

Guide Rail Fitting

TOK Application Table

Model	Applicable Motor Output
TOK4-P	0.25 to 0.75kW
TOK2-65	1.5kW
TOK2-65T	2.2 to 3.7kW

Accessories

- Duckfoot Bend
- Guide Hook
- Guide Support with Bolts & Nuts
- Lifting Chain with Shackles (4m for TOK4-P, 5m for TOK2-65 / 65T)

Applications

- Draining treated water at small-scale wastewater treatment facility
- Pumping rainwater and springwater from basement
- Supplying treated water for defoaming at small-scale wastewater treatment facility

Cable Cables

Single-phase

Model	100-120V		200-240V		Length m	Material
	Cores x mm ²	Outer Dia. mm	Cores x mm ²	Outer Dia. mm		
40PSF2.25S	3 x 1.25	10.1	3 x 1.25	10.1	5	PVC
40PSF2.4S	3 x 1.25	10.1	3 x 1.25	10.1		

Three-phase

Model	200-240V		380-600V		Length m	Material
	Cores x mm ²	Outer Dia. mm	Cores x mm ²	Outer Dia. mm		
40PSF2.25	4 x 1.25	11.1	4 x 1.25	11.1	6	PVC
40PSF2.4	4 x 1.25	11.1	4 x 1.25	11.1		
50PSF2.75	4 x 1.25	11.1	4 x 1.25	11.1		
50PSF21.5	4 x 1.25	11.1	4 x 1.25	11.1		
65PSF22.2	4 x 2.0	11.8	4 x 1.25	11.1		
65PSF23.7	4 x 3.5	13.9	4 x 2.0	11.8		

Performance Curves

Standard, Automatic and Auto-alternation models have the identical performance.

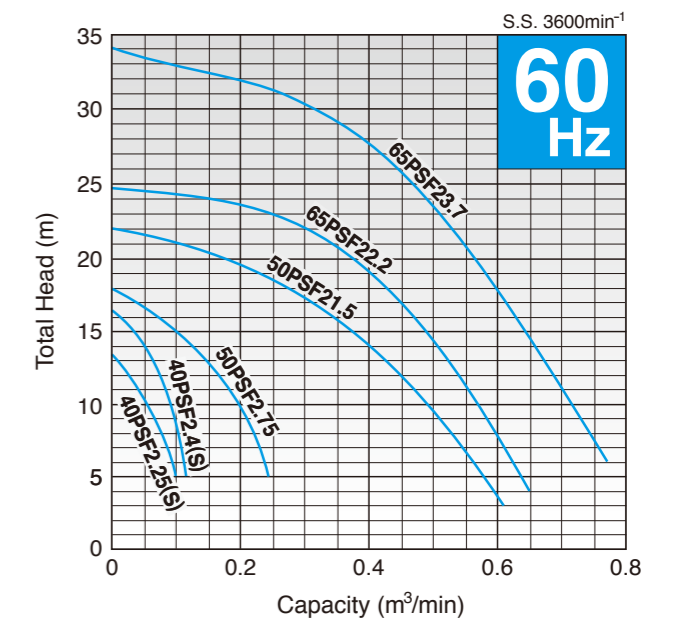
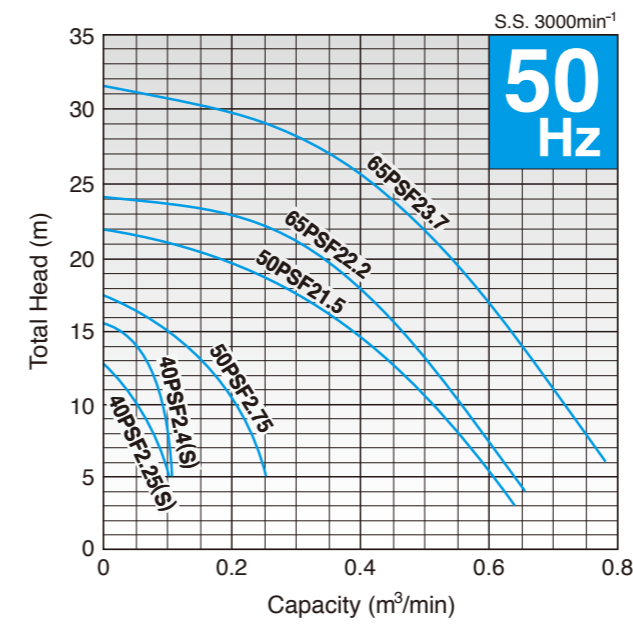

Model Selection

Discharge Bore mm	Model			Motor Output kW	Phase	Starting Method	Solids Passage mm	Dry Weight kg	
	Standard	Automatic	Auto-alternation					Standard	Auto & Auto-alternation
40	40PSF2.25S	40PSFA2.25S	40PSFW2.25S	0.25	Single	Capacitor Run	8	7.3	7.9
40	40PSF2.25	40PSFA2.25	40PSFW2.25	0.25	Three	D.O.L.	8	6.2	6.9
40	40PSF2.4S	40PSFA2.4S	40PSFW2.4S	0.4	Single	Capacitor Run	8	7.3	7.9
40	40PSF2.4	40PSFA2.4	40PSFW2.4	0.4	Three	D.O.L.	8	7.1	7.8
50	50PSF2.75	50PSFA2.75	50PSFW2.75	0.75	Three	D.O.L.	8	8.4	9.1
50	50PSF21.5	50PSFA21.5	50PSFW21.5	1.5	Three	D.O.L.	13	16.0	16.9
65	65PSF22.2	65PSFA22.2	65PSFW22.2	2.2	Three	D.O.L.	13	22.0	23.0
65	65PSF23.7	65PSFA23.7	65PSFW23.7	3.7	Three	D.O.L.	13	27.0	28.0

• Weights excluding cable

Dimensions

Model	d	A	B	H	Unit: mm	
					W1	W2
40PSF2.25S	40	236	162	360	325	110
40PSF2.25	40	236	162	349	310	110
40PSF2.4S	40	236	162	360	325	110
40PSF2.4	40	236	162	360	325	110
50PSF2.75	50	236	162	374	335	110
50PSF21.5	50	295	196	435	390	110
65PSF22.2	65	311	212	559	500	130
65PSF23.7	65	311	212	594	535	130

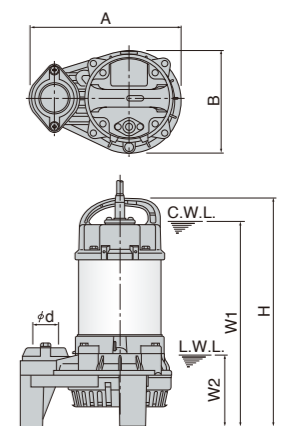

C.W.L.: Continuous Running Water Level
L.W.L.: Lowest Running Water Level

PLS

The PLS-series is a horizontal semi-vortex pump designed for handling water carrying small solid matters. The horizontal design makes it possible to operate at a low water level or in a shallow sump. Since the pump is made of special resin and stainless steel, it is corrosion-resistant and lightweight.



Standard Accessory

Major Components & Specifications

Discharge Bore	mm	50	
Pumping Fluid	Type of Fluid	Wastewater and Water carrying Small Solid Matters	
	Fluid Temperature	0 to 40°C	
Pump	Impeller	Vortex	
	Shaft Seal	Double Mechanical Seal (with Oil Lifter)	
	Bearing	Double-shielded Ball Bearing	
	Impeller	Glass-fiber Reinforced Resin	
	Casing	Glass-fiber Reinforced Resin	
Motor	Type, Pole	Dry-type Submersible Induction Motor, 2-pole	
	Insulation	Class E	
	Phase	Single-phase	
	Starting Method	Capacitor Run	
	Protection Device (Built-in)	Circle Thermal Protector (0.75kW only) Miniature Thermal Protector	
	Lubricant	Liquid Paraffin (ISO VG32)	
	Materials	Frame	304 Stainless Steel
		Shaft	420 Stainless Steel (0.15kW only) 304 Stainless Steel
Cable		PVC	
Discharge Connection	Screwed Flange		

Applications

- Pumping rainwater and springwater at a place where foreign objects are likely to run into the water
- Transferring wastewater between the tanks at small-scale treatment facility
- Circulating water in waterscape garden (e.g. waterfall, fountain, koi pond, etc.)

Cable Cables

Model	100-120V		200-240V		Length m	Material
	Cores x mm ²	Outer Dia. mm	Cores x mm ²	Outer Dia. mm		
50PLS2.15S	3 x 1.25	10.1	3 x 1.25	10.1	5	PVC
50PLS2.4S	3 x 1.25	10.1	3 x 1.25	10.1		
50PLS2.75S	3 x 1.25	10.1	3 x 1.25	10.1		

Comparison of Continuous Running Water Level

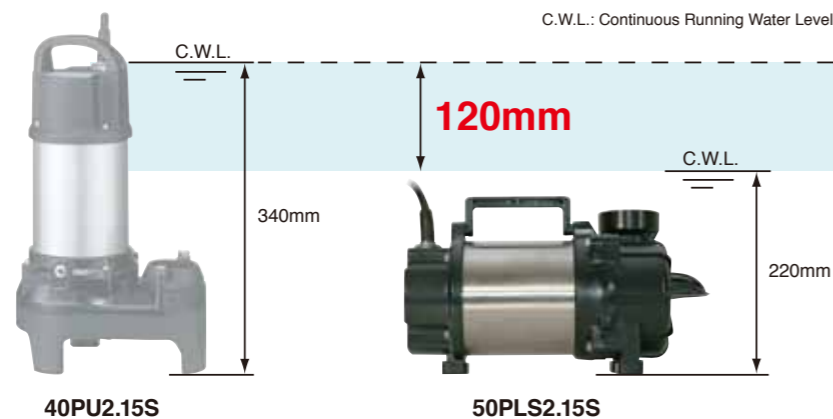

Performance Curves

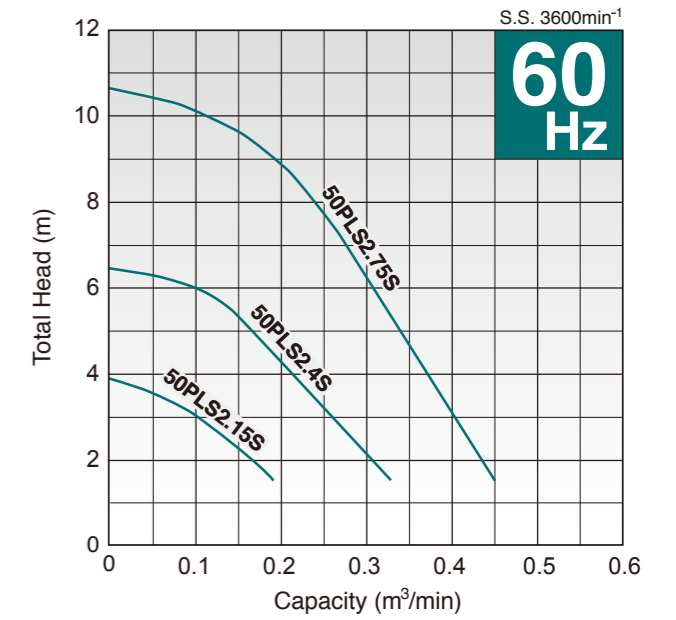
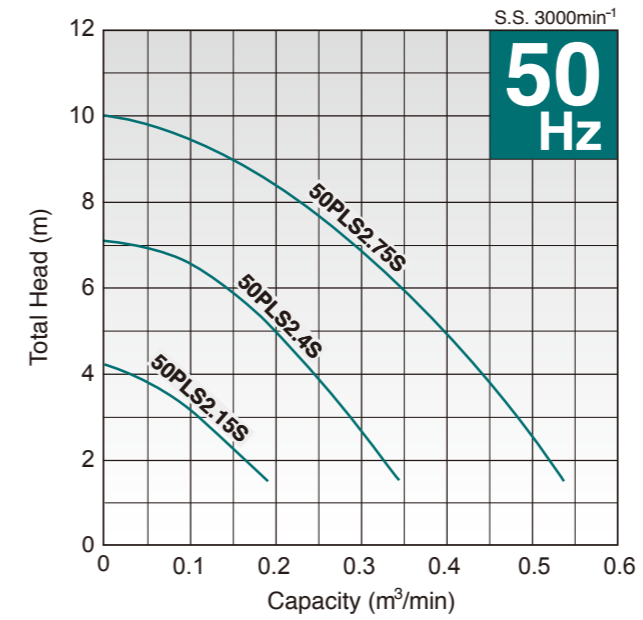

Model Selection

Discharge Bore mm	Model	Motor Output kW	Phase	Starting Method	Solids Passage mm	Dry Weight kg
50	50PLS2.15S	0.15	Single	Capacitor Run	38 (10)	5.8
50	50PLS2.4S	0.4	Single	Capacitor Run	24 (10)	6.7
50	50PLS2.75S	0.75	Single	Capacitor Run	24 (10)	8.6

- Figure in () shows the solids passage of the pump with a strainer.
- Weights excluding cable

Dimensions

Model	d	A	B	H1	H2	Unit: mm	
						W	
50PLS2.15S	50	341	142	180	185	220	
50PLS2.4S	50	342	150	185	200	220	
50PLS2.75S	50	362	150	185	201	310	

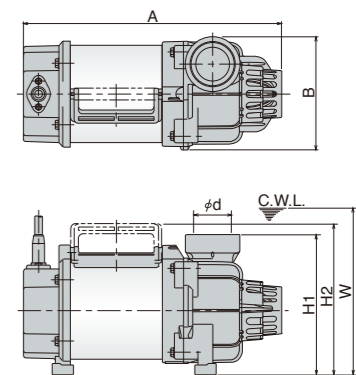

C.W.L.: Continuous Running Water Level



The TM-series is a semi-vortex pump, which is constructed of titanium and special resin. Titanium has a superb corrosion resistance against seawater. Being all wetted metal parts made of titanium, the pump is suitable for the intake, transfer, and drainage of seawater.



Major Components & Specifications

Discharge Bore	mm	40	50	80
Pumping Fluid	Type of Fluid	Seawater		
	Fluid Temperature	0 to 40°C		
Pump	Structure	Impeller	Vortex	
		Shaft Seal	Double Mechanical Seal (with Oil Lifter)	
		Bearing	Double-shielded Ball Bearing	
	Materials	Impeller	Glass-fiber Reinforced Resin	
		Casing	Glass-fiber Reinforced Resin	
	Shaft seal	Silicon Carbide		
Motor	Type, Pole	Dry-type Submersible Induction Motor, 2-pole		
	Insulation	Class E		
	Phase	Single-phase (suffix "S") Three-phase		
	Starting Method	Capacitor Run (single-phase only) Direct on Line		
	Protection Device (Built-in)	Circle Thermal Protector Miniature Thermal Protector (single-phase only)		
	Lubricant	Liquid Paraffin (ISO VG32)		
	Materials	Frame	Titanium	
Shaft		Titanium		
Cable		PVC		
Discharge Connection	Screwed Flange			

Corrosion Tests (in Seawater / 6 months)

Material	Stepped Shaft	Shaft Tap
Titanium		
304 Stainless Steel		

Applications

- Pumping seawater from bilge and pit of vessel
- Supplying seawater to aquarium
- Circulating seawater in breeding pond

Cable Cables

Single-phase

Model	100-120V		200-240V		Length m	Material
	Cores x mm ²	Outer Dia. mm	Cores x mm ²	Outer Dia. mm		
40TM2.25S	3 x 1.25	10.1	3 x 1.25	10.1	5	PVC
50TM2.4S	3 x 1.25	10.1	3 x 1.25	10.1		

Three-phase

Model	200-240V		380-600V		Length m	Material
	Cores x mm ²	Outer Dia. mm	Cores x mm ²	Outer Dia. mm		
40TM2.25	4 x 1.25	11.1	4 x 1.25	11.1	6	PVC
50TM2.4	4 x 1.25	11.1	4 x 1.25	11.1		
50TM2.75	4 x 1.25	11.1	4 x 1.25	11.1		
50TM2.1.5	4 x 1.25	11.1	4 x 1.25	11.1		
80TM22.2	4 x 2.0	11.8	4 x 1.25	11.1		
80TM23.7	4 x 3.5	13.9	4 x 2.0	11.8		

Performance Curves

Standard and Automatic models have the identical performance.

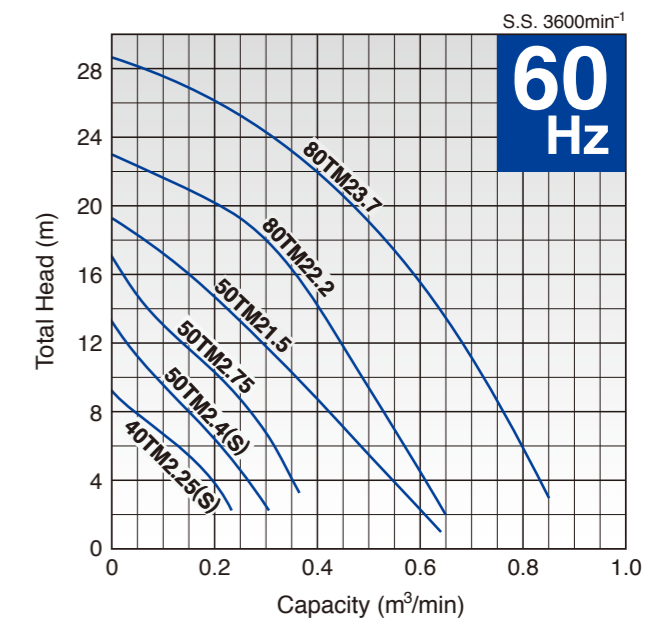
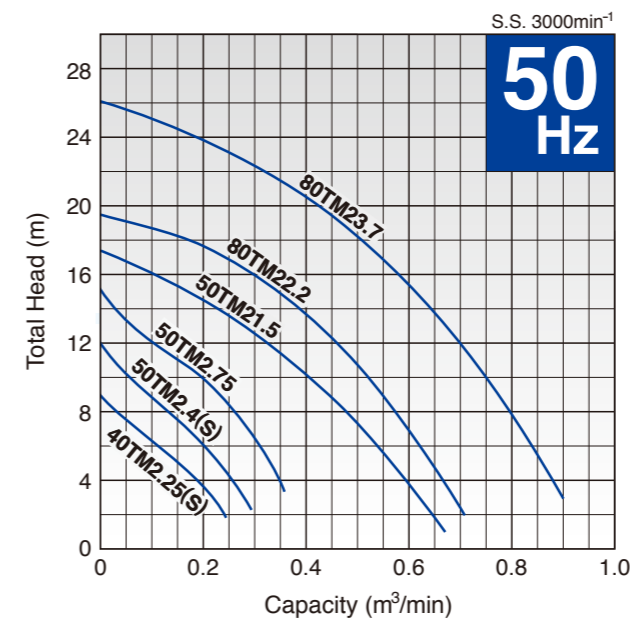

Model Selection

Discharge Bore mm	Model		Motor Output kW	Phase	Starting Method	Solids Passage mm	Dry Weight kg	
	Standard	Automatic					Standard	Auto & Auto-alternation
40	40TM2.25S	40TMA2.25S	0.25	Single	Capacitor Run	10	6.7	7.2
40	40TM2.25	40TMA2.25	0.25	Three	D.O.L.	10	5.7	6.2
50	50TM2.4S	50TMA2.4S	0.4	Single	Capacitor Run	10	6.7	7.2
50	50TM2.4	50TMA2.4	0.4	Three	D.O.L.	10	6.6	7.1
50	50TM2.75	50TMA2.75	0.75	Three	D.O.L.	10	7.8	8.4
50	50TM2.1.5	50TMA2.1.5	1.5	Three	D.O.L.	20	14.9	15.6
80	80TM22.2	80TMA22.2	2.2	Three	D.O.L.	20	21.0	22.0
80	80TM23.7	80TMA23.7	3.7	Three	D.O.L.	20	26.0	27.0

• Weights excluding cable

Dimensions

Model	d	A	B	H	W1	W2
40TM2.25S	40	236	162	360	325	110
40TM2.25	40	236	162	349	310	110
50TM2.4S	50	236	162	360	325	110
50TM2.4	50	236	162	360	325	110
50TM2.75	50	236	162	374	335	110
50TM2.1.5	50	295	196	435	390	110
80TM22.2	80	311	212	559	500	130
80TM23.7	80	311	212	594	535	130

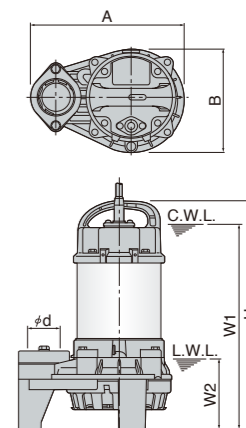

C.W.L.: Continuous Running Water Level
L.W.L.: Lowest Running Water Level

OM

The OM-series is the most compact and economic pump in the VANCS-series. It is a semi-vortex design and can handle liquids containing moderate size of solids. Since the pump is made of special resin and stainless steel, it is corrosion-resistant and lightweight.

Applications

- Pumping rainwater and springwater from basement
- Circulating water in waterscape garden (e.g. waterfall, fountain, koi pond, etc.)

Performance Curves

Standard and Automatic models have the identical performance.

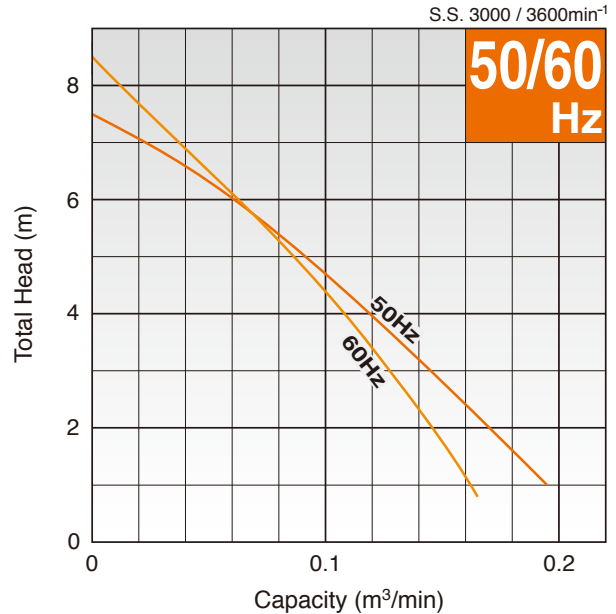

Major Components & Specifications

Discharge Bore		mm	32
Pumping Fluid	Type of Fluid	Wastewater and Water carrying Small Solid Matters	
	Fluid Temperature	0 to 40°C	
Pump	Structure	Impeller	Vortex
		Shaft Seal	Double Mechanical Seal
		Bearing	Double-shielded Ball Bearing
	Materials	Impeller	Glass-fiber Reinforced Resin
		Casing	Glass-fiber Reinforced Resin
	Shaft seal	Silicon Carbide	
Motor	Type, Pole	Dry-type Submersible Induction Motor, 2-pole	
	Insulation	Class E	
	Phase	Single-phase	
	Starting Method	Capacitor Run	
	Protection Device (Built-in)	Miniature Thermal Protector	
	Lubricant	Liquid Paraffin (ISO VG32)	
	Materials	Frame	304 Stainless Steel
Shaft		420 Stainless Steel	
Cable		PVC	
Discharge Connection		Screwed Flange	

Dimensions

Unit: mm

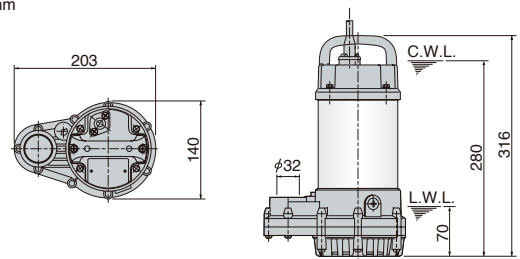

C.W.L.: Continuous Running Water Level
L.W.L.: Lowest Running Water Level

Model Selection

Discharge Bore mm	Model		Motor Output kW	Phase	Starting Method	Solids Passage mm	Dry Weight kg		Cable			
	Standard	Automatic					Standard	Automatic	100-240V		Length m	Material
									Cores × mm²	Outer Dia. mm		
32	OM3	OMA3	0.15	Single	Capacitor Run	10	5.9	6.1	3 × 0.75	9.2	3	PVC

• Weights excluding cable

We reserve the right to change the specifications and designs for improvement without prior notice.

**TSURUMI
MANUFACTURING CO., LTD.**

Your Dealer