

# KTZ/KTD

DEWATERING PUMPS





We Are Original

## Submersible Heavy-duty Dewatering Pumps

The KTZ-series is Tsurumi's flagship line of submersible pumps. Made with a cast iron body and high chromium cast iron impeller, the pumps can withstand the most demanding conditions found in construction, aggregate and mining applications. Versatility is increased as each model has the capability of being easily converted between high head and high volume performance with a simple change of impeller, suction cover and hose coupling.

Dual silicon carbide mechanical seals are isolated in the oil chamber to protect the seal faces against abrasion and corrosion. In addition, the seals are enclosed in Tsurumi's patented Oil Lifter to ensure reliable lubrication and cooling. This design exceeds the standard configuration of competitors and offers a longer mechanical seal life for a more reliable pump.

Pumps with a 7.5 to 15kW motor incorporate seal pressure relief ports, therefore mechanical seals are exposed only to the pressure developed by the sump submergence level. This virtually eliminates the premature wear and failure of mechanical seals in higher pressure applications.

The KTZE-series is an automatic pump without cumbersome floats. An innovative electrode type relay unit built into the pump automatically starts and stops the pump to eliminate dry-running. This mechanism greatly reduces power consumption and extends operating life.

The KTD-series is a submersible heavy-duty slurry pump utilizing the KTZ-series as the base. It is designed to have more motor shaft power allowance than the KTZ to handle muddy water with higher specific gravities. An agitator suspends solids to assist in pumping sediments in combination with a dedicated strainer. This pump is suitable for transferring or draining bentonite slurry.

Available as optional specifications are a proprietary "seawater-resistant pump" developed over many years by Tsurumi to enable seawater intake/drainage for long periods of time, and an "all stainless steel pump" using 316 stainless steel for mining markets.

### *Registration of Design*

*Tsurumi has registered the design of the KTZ-series in major countries.  
Design rights are granted under the laws of each country.*

**KTZ:** Tsurumi's flagship line of heavy-duty drainage pumps

**KTZE:** Automatic drainage pumps with an innovative electrode type relay unit

**KTD:** Slurry pumps that deliver powerful agitation for discharging slurries laden with silt, earth, sand or other particulate

### Selection Table

Motor Output		1.5kW	2-2.2kW	3-3.7kW	5.5kW	7.5kW	11kW	15kW
<b>KTZ</b>	2" 50mm							
	3" 80mm							
	4" 100mm							
	6" 150mm							
<b>KTZE</b> -Automatic-	2" 50mm							
	3" 80mm							
	4" 100mm							
<b>KTD</b> -Slurry-	2" 50mm							
	3" 80mm							

### Model Number Designation

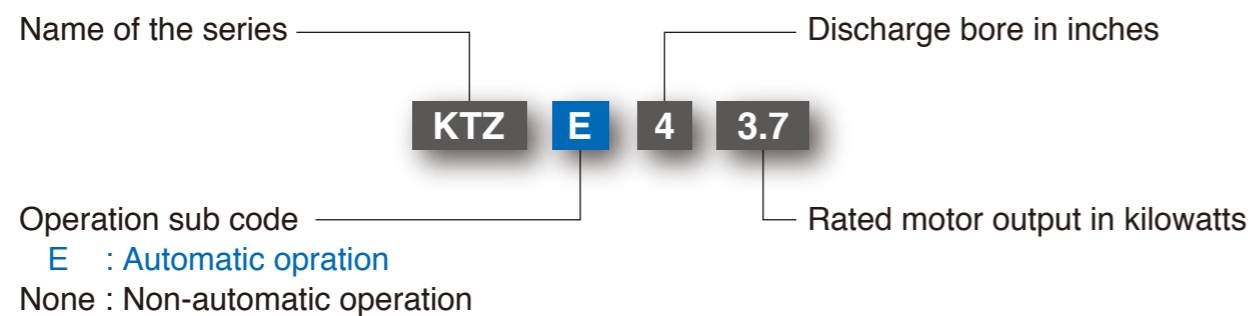

### Options

- Seawater-resistant version; Galvanic anode & Special impeller
- High temperature liquids version; Max. 90°C
- High voltage version; Max. 1000V
- All stainless steel version; 316 S.S.

### Seawater-Resistant Version

Tsurumi's pumps can be combined with a seawater-resistant kit (optional) that adds a "galvanic anode" and "seawater-resistant special cast iron impeller," and enables about two years of service. (The service period depends on operating conditions.) For details, refer to the Seawater-Resistant Pumps catalog [IB115].



### High Temperature Liquids Version

Tsurumi's pumps are applicable to high temperature liquids of up to 90°C. Pumps of the standard specification can discharge liquids of up to 40°C. However, there are many fields that need to discharge higher temperature liquids, e.g., discharging industrial water from a power plant or ironworks, or discharging hot spring water from a mine in a volcanic zone.

### High Voltage Version

Tsurumi's pumps can be fabricated to 690V or 1000V ratings that are often required for mining applications. The pumps meet mining safety standards as they come with shielded cables and motors with built-in diodes for ground-fault checks.

### All Stainless Steel Version

All of the parts of Tsurumi's pumps that contact fluid, including the impeller, pump casing, motor frame, strainer stand, and hose coupling, can be made in 316 stainless steel. Tsurumi's all stainless steel pump can handle corrosive fluids generated in mines or quarries, and chemical fluids of low pH value.



## Top Discharge, Side Flow Design

This design assures efficient motor cooling even if the pump runs with its motor exposed to air, and also allows the overall diameter of the pump to be reduced for installation in confined spaces.

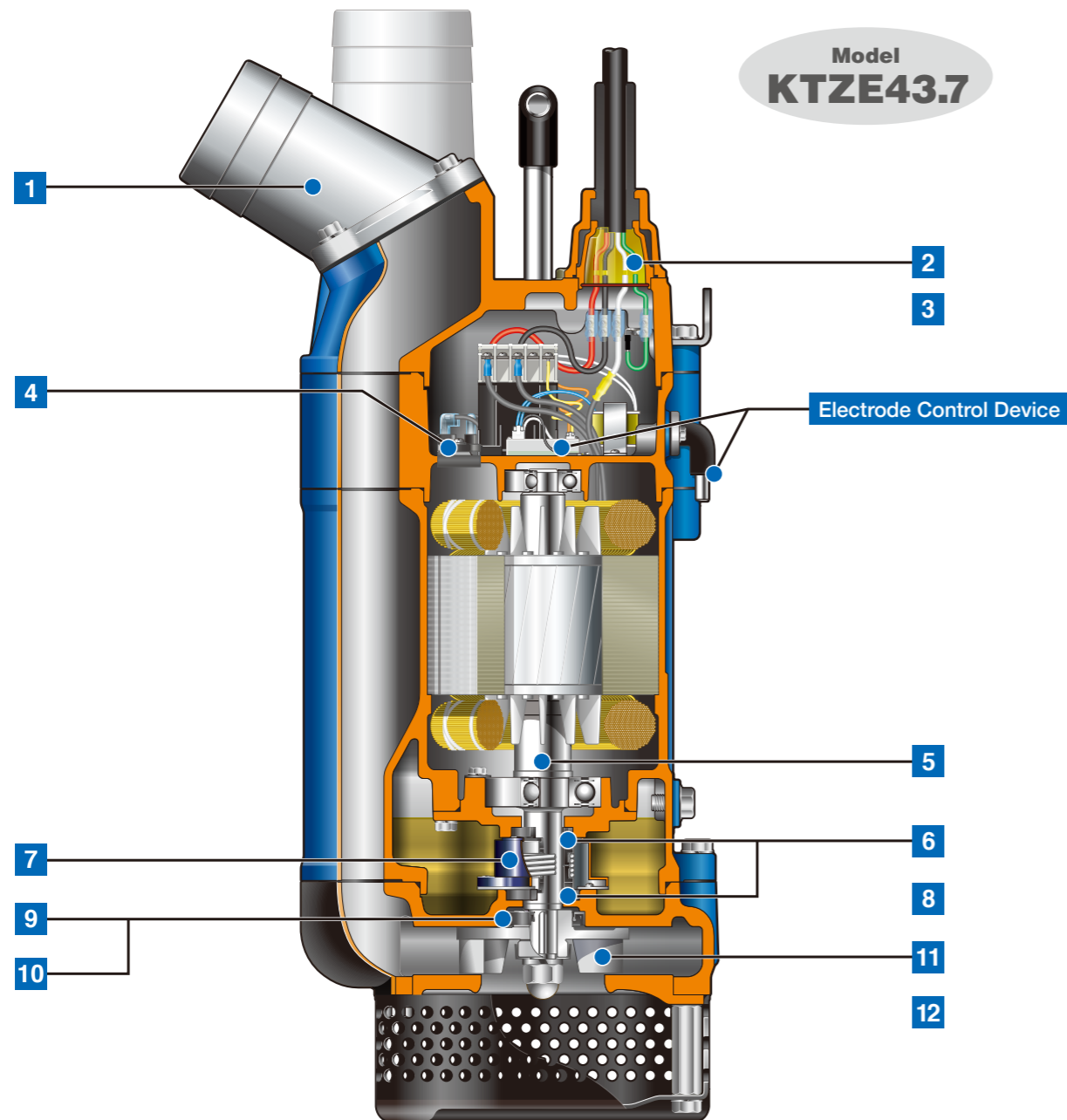

### Electrode Control Device (KTZE)

Consisting of an electric probe and relay unit, this enables automatic operation, reduces power consumption and extends operating life.

### 1 Multi-directional Hose Coupling (KTZ & KTZE)

Can be configured for inclined or vertical discharge, allowing for smoother installation.

### 2 Anti-wicking Cable Entry

Prevents water incursion due to capillary action should the cable sheath be damaged or the end of cable submerged. Also prevents moist air from infiltrating the motor housing and condensation from forming inside the housing due to temperature differences between the housing and outside air.

### 3 Cable Clip

Prevents unexpected water incursion that can occur if the cable is damaged, by protecting the cable against the tugging and rough handling found at construction sites.

### 4 Circle Thermal Protector

Directly cuts the motor circuit if excessive heat builds up or overcurrent occurs in the motor.

# 40 % Reduction in Power Consumption

## Electrode Control Device

Tsurumi has developed a unique automatic control device utilizing an electrode. It consists of an electric probe and relay unit. When the water level rises to contact the electric probe, electric continuity is produced between the electrode and the pump body, and the relay unit built into the pump turns on the pump.

The relay unit includes a timer function. The pump stops automatically in about one minute after the water surface falls below the electric probe. If the water level rises again to contact the electric probe within the run time, the pump continues to run for one more minute.

Since this mechanism eliminates dry-running, the pump can reduce power consumption by up to 40 percent compared with non-automatic pumps (Tsurumi comparison). It also prevents chattering caused by a turbulent water surface and extends operating life.

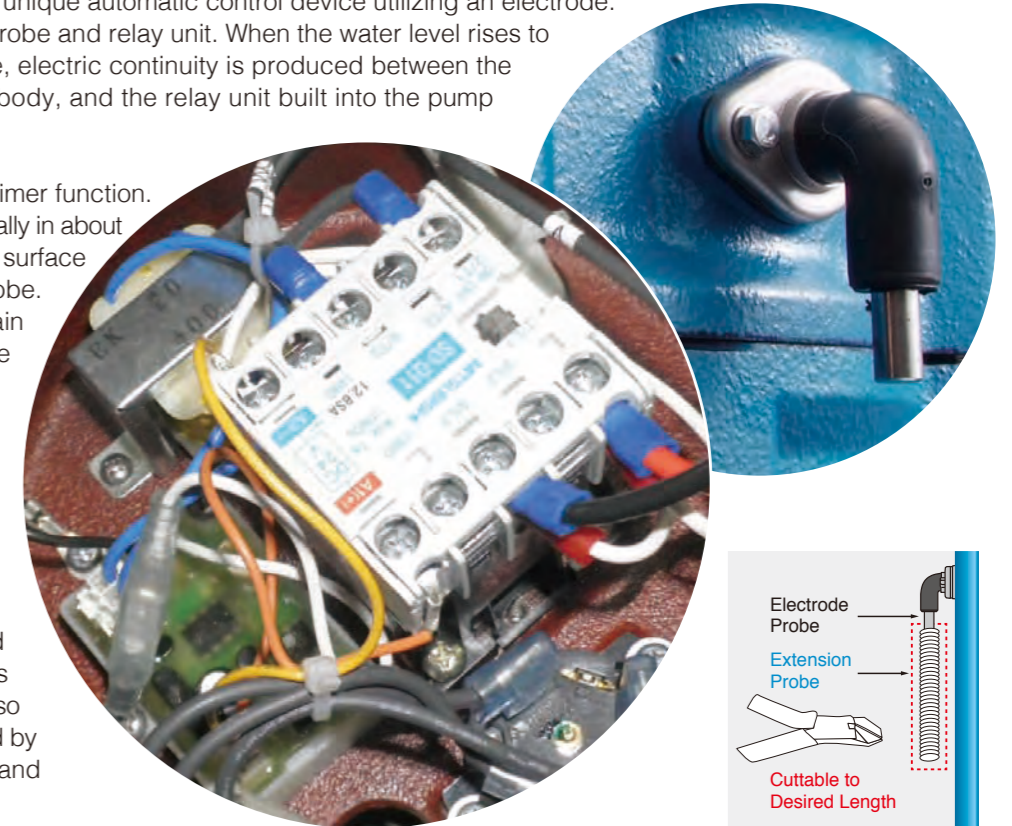

It is possible to set a lower starting water level by using an extension probe (optional accessory). The starting water level is adjustable because the extension probe can be cut to the desired length as it is made of coil spring.

### 5 Shaft

Quenching treatment is applied to parts that contact particles in pumped fluids and whose mechanical seal may wear out, to enhance surface hardness and extend shaft service life.

### 6 Dual Inside Mechanical Seals with Silicon Carbide Faces

Isolated in the oil chamber where a clean, non-corrosive and abrasion-free lubricating environment is maintained. Compared with the water-cooled outside mechanical seal, it reduces the risk of failure caused by dry-heating and adhering matter. The silicon carbide provides 5 times higher corrosion, wear and heat resistance than the tungsten carbide. Rubber parts of the upper and lower fixing rings are made of NBR or FPM (FKM), which provides higher resistance to heat and chemicals.

### 7 Oil Lifter [Patented]

Provides lubrication and cooling of the seal faces down to 1/3 of normal oil level, thus maintaining a stable shaft sealing effect and prolonging seal life longer.

### 8 Seal Pressure Relief Ports (7.5kW and above)

Protect the mechanical seal from pump pressure. They also protect the seal face by discharging wear particles.

### 9 Oil Seal (5.5kW and below)

Used as a "Dust Seal", it protects the mechanical seal from abrasive particles.

### 10 Labyrinth Ring (7.5kW and above)

Equipped to provide a better countermeasure against wear caused by high pressure generated in the casing and improve the maintainability.

### 11 High-chromium Cast Iron Semi-open Impeller

Resists wear caused by abrasive particles and enables the pump to maintain its original performance for an extended period of time.

### 12 Agitating Mechanism (KTD)

Consists of a shaft-mounted agitator and a dedicated strainer. The agitator made of high-chromium cast iron resists wear caused by abrasive particles, and it suspends solids to assist in pumping sediments in combination with the strainer.

# KTZ –Flagship Line–

The KTZ-series is a submersible three-phase cast iron high head heavy-duty drainage pump. The cast iron body with high-chromium cast iron impeller enables it to withstand demanding conditions found in construction, aggregate and mining applications. The top discharge, side flow design assures efficient motor cooling even when it operates with its motor exposed to air. The slim design allows the pump to be placed in a confined space. The discharge direction is selectable between vertical and inclined, which prevents folding or bending of the discharge hose. The pump with 7.5 to 15kW motor incorporates seal pressure relief ports that prevent the pumping pressure from applying to the shaft seal.



Discharge Bore mm	Model	Motor Output kW	Phase	Starting Method	Solids Passage mm	Dry Weight* <sup>2</sup> kg	Cable Length m
50	KTZ21.5	1.5	Three	D.O.L.	8.5	34	8
50	KTZ22.2	2.2		D.O.L.	8.5	35	8
50	KTZ23.7	3.7		D.O.L.	8.5	60	8
80	KTZ31.5	1.5		D.O.L.	8.5	33	8
80	KTZ32.2	2.2		D.O.L.	8.5	34	8
80	KTZ33.7	3.7		D.O.L.	8.5	60	8
80	KTZ35.5	5.5		D.O.L.* <sup>1</sup>	8.5	74	8
100	KTZ43.7	3.7		D.O.L.	8.5	60	8
100	KTZ45.5	5.5		D.O.L.* <sup>1</sup>	8.5	74	8
100	KTZ47.5	7.5		D.O.L.* <sup>1</sup>	12	101	8
100	KTZ411	11		D.O.L.* <sup>1</sup>	12	133	8
100	KTZ415	15		D.O.L.* <sup>1</sup>	12	146	8
150	KTZ67.5	7.5		D.O.L.* <sup>1</sup>	20	100	8
150	KTZ611	11		D.O.L.* <sup>1</sup>	20	133	8
150	KTZ615	15		D.O.L.* <sup>1</sup>	20	147	8

\*<sup>1</sup> Star-Delta available upon request

\*<sup>2</sup> Weights excluding cable

## Performance Curves

< 50-80mm >

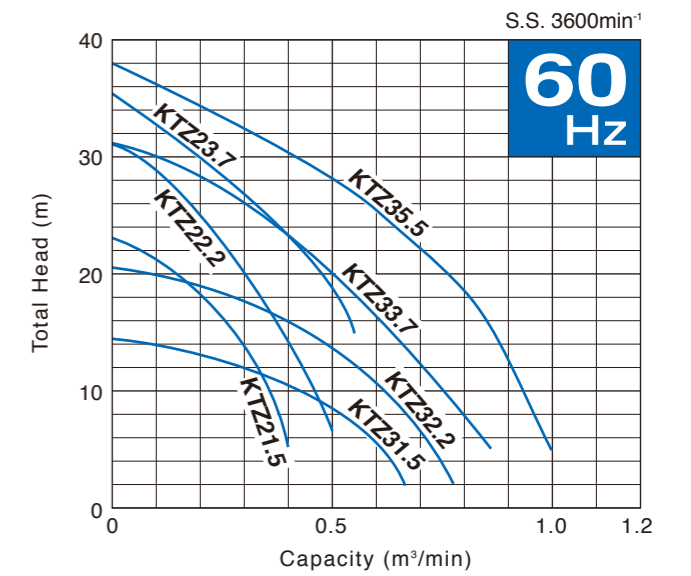
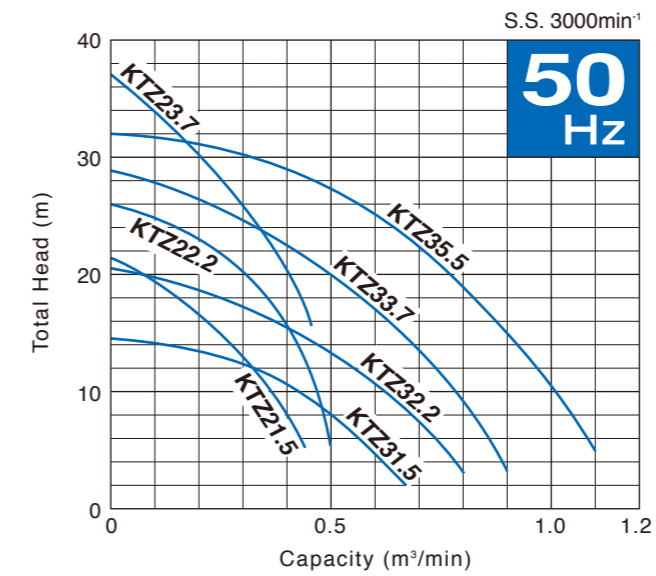

< 100-150mm >

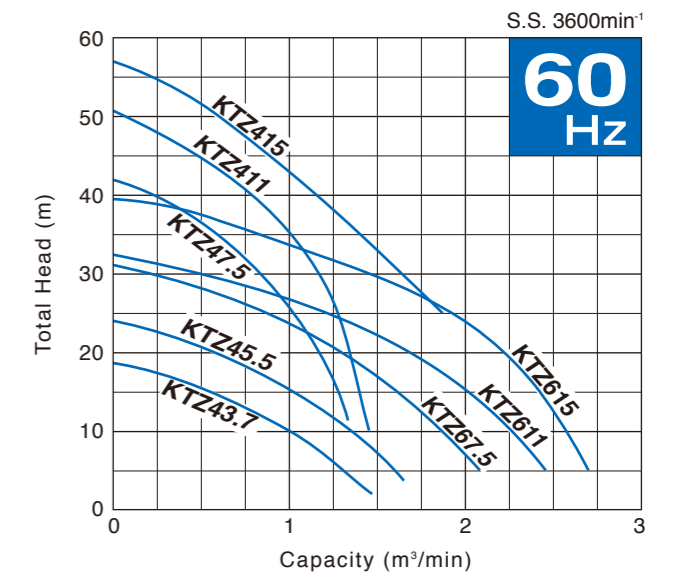
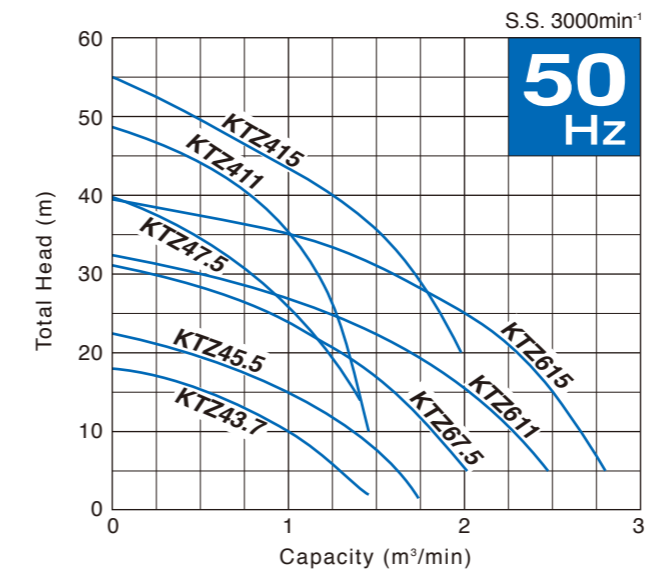

## Dimensions

Unit: mm

Model	d	A	A1	B	D	H	W1
KTZ21.5	50	270	235	543	216	548	120
KTZ22.2	50	270	235	563	216	568	120
KTZ23.7	50	342	283	675	252	637	150
KTZ31.5	80	276	235	543	216	548	120
KTZ32.2	80	276	235	563	216	568	120
KTZ33.7	80	347	283	675	252	637	150
KTZ35.5	80	358	306	719	258	688	150
KTZ43.7	100	367	283	690	252	637	150
KTZ45.5	100	377	306	734	258	688	150
KTZ47.5	100	399	330	812	314	697	190
KTZ411	100	428	374	864	350	740	190
KTZ415	100	428	374	934	350	810	190
KTZ67.5	150	445	361	875	314	697	190
KTZ611	150	457	374	884	350	740	190
KTZ615	150	457	374	954	350	810	190

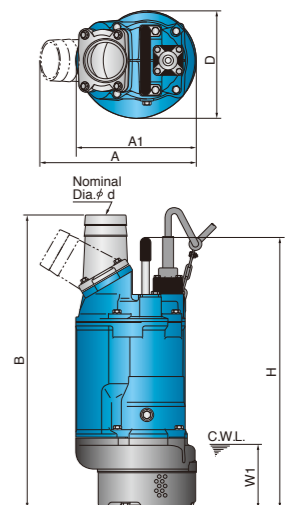

# KTZE – Automatic Operation with Electrode–

The KTZE-series is a submersible three-phase automatic cast iron high head heavy-duty drainage pump. An innovative electrode type relay unit built into the pump automatically starts and stops the pump to eliminate dry-running. This mechanism greatly reduces power consumption and extends operating life. The cast iron body with high-chromium cast iron impeller enables it to withstand demanding conditions found in construction, aggregate and mining applications. The top discharge, side flow design assures efficient motor cooling even when it operates with its motor exposed to air. The slim design allows the pump to be placed in a confined space. The discharge direction is selectable between vertical and inclined, which prevents folding or bending of the discharge hose.



Discharge Bore mm	Model	Motor Output kW	Phase	Starting Method	Solids Passage mm	Dry Weight* kg	Cable Length m
50	KTZE21.5	1.5	Three	D.O.L.	8.5	39	8
50	KTZE22.2	2.2		D.O.L.	8.5	41	8
50	KTZE23.7	3.7		D.O.L.	8.5	69	8
80	KTZE31.5	1.5		D.O.L.	8.5	38	8
80	KTZE32.2	2.2		D.O.L.	8.5	40	8
80	KTZE33.7	3.7		D.O.L.	8.5	69	8
100	KTZE43.7	3.7		D.O.L.	8.5	69	8

\* Weights excluding cable

## Performance Curves

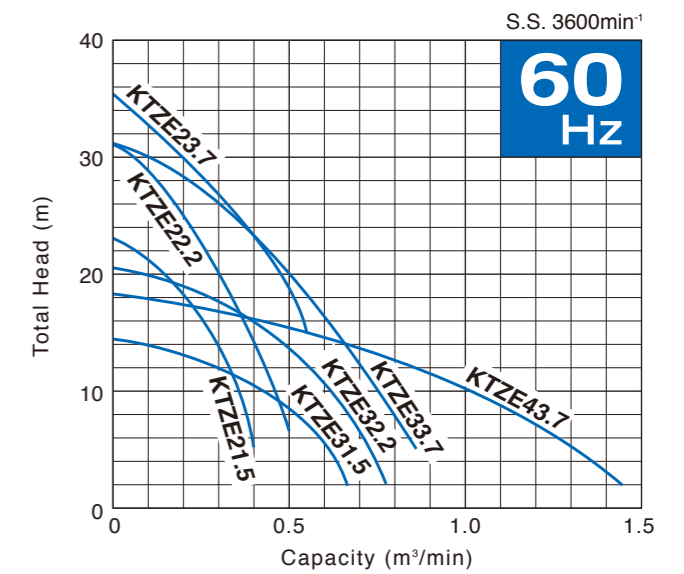
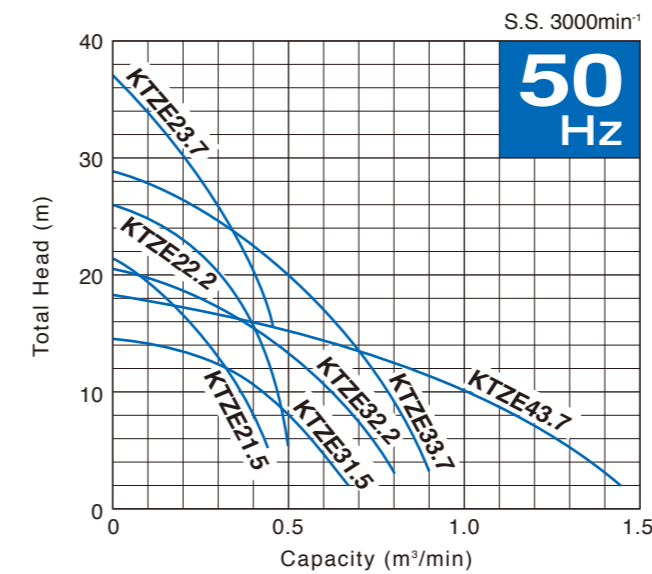

## Dimensions

Model	d	A	A1	B	D	H	W1
KTZE21.5	50	270	235	623	216	628	345
KTZE22.2	50	270	235	643	216	648	355
KTZE23.7	50	342	283	755	252	717	435
KTZE31.5	80	276	235	623	216	628	345
KTZE32.2	80	276	235	643	216	648	355
KTZE33.7	80	347	283	755	252	717	435
KTZE43.7	100	367	283	770	252	717	435

Unit: mm

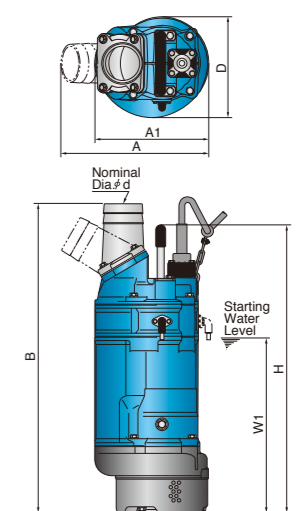

## Automatic Operation

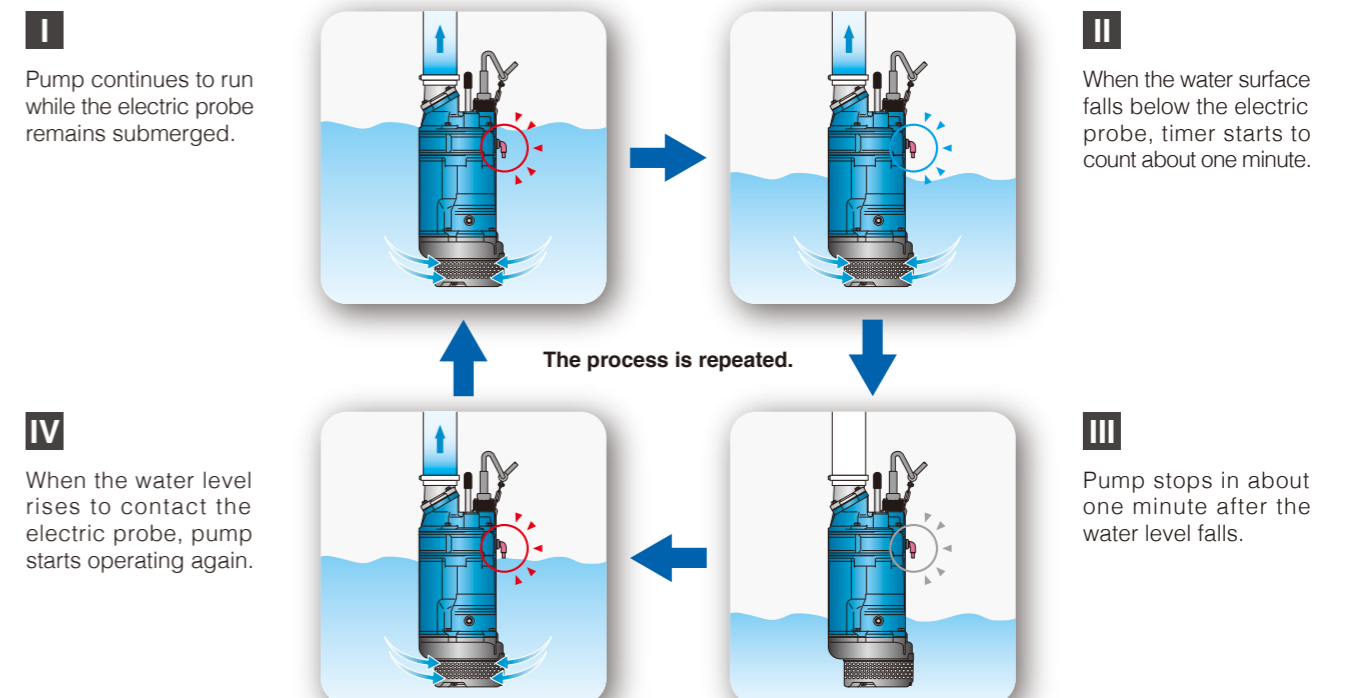

# KTD –Slurry Pumps with Agitator–

The KTD-series is a submersible three-phase cast iron heavy-duty slurry pump. It is equipped with an agitator that assists smooth suction of the settled matters. The pump parts such as the impeller and the suction cover are made of wear-resistant materials. The top discharge, side flow design assures efficient motor cooling even when it operates with its motor exposed to air. The slim design allows the pump to be placed in a confined space.



Discharge Bore mm	Model	Motor Output kW	Phase	Starting Method	Solids Passage mm	Dry Weight* kg	Cable Length m
50	<b>KTD22.0</b>	2	Three	D.O.L.	10	38	8
80	<b>KTD33.0</b>	3		D.O.L.	10	65	8

\* Weights excluding cable

## Performance Curves

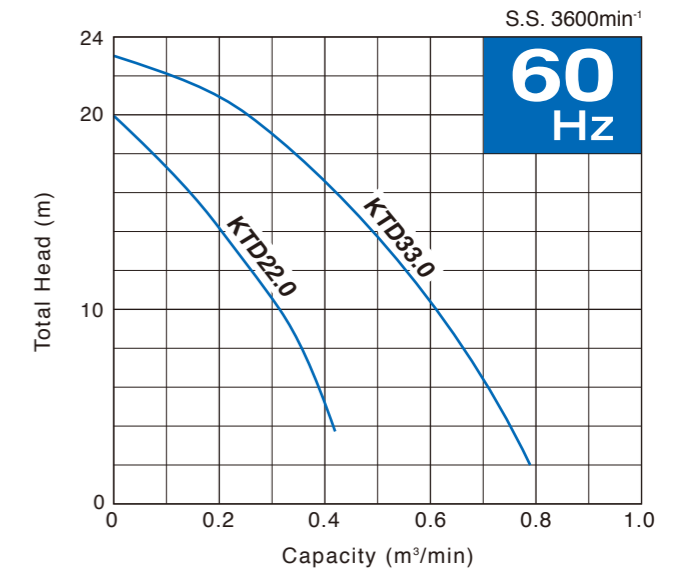
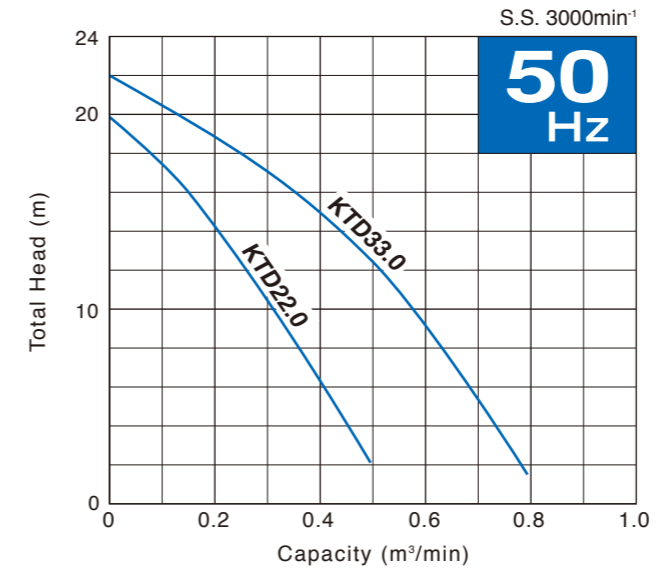

## Dimensions

Model	d	A	B	D	H	W1
<b>KTD22.0</b>	50	235	550	221	519	140
<b>KTD33.0</b>	80	297	644	266	654	160

Unit: mm

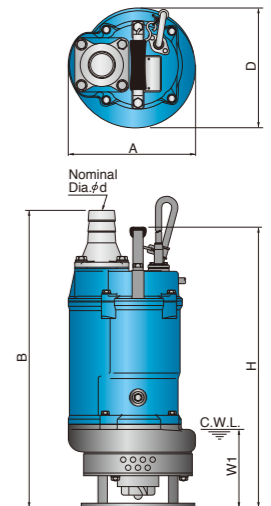

## Agitator

Tsurumi's slurry pumps have an agitator made of abrasion resistant material. It is mounted on the shaft and rotates to create a downward current. This agitator assists the pump in sucking and transferring bentonite slurry, slime, mud, and water with high sand content.

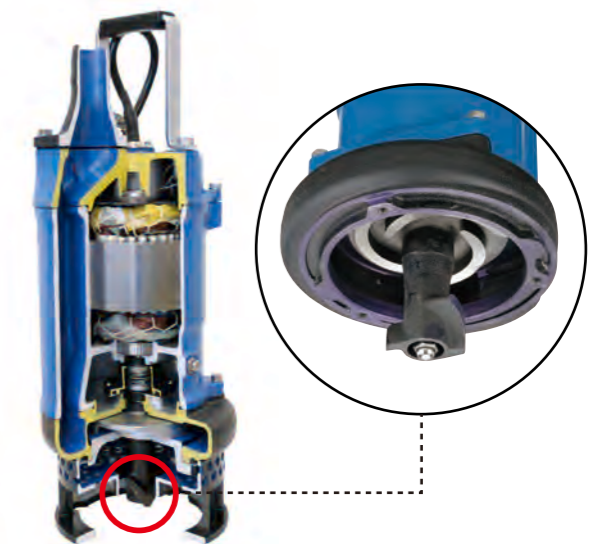

# Specifications

		KTZ											KTZ				KTZE -Automatic-							KTD -Slurry-			
		KTZ21.5	KTZ22.2	KTZ23.7	KTZ31.5	KTZ32.2	KTZ33.7	KTZ35.5	KTZ43.7	KTZ45.5	KTZ47.5	KTZ411		KTZ415	KTZ67.5	KTZ611	KTZ615	KTZE21.5	KTZE22.2	KTZE23.7	KTZE31.5	KTZE32.2	KTZE33.7	KTZE43.7	KTD22.0	KTD33.0	
PUMP	Discharge Bore mm	50			80				100					100	150			50			80			100	50	80	
	Discharge Connection	Hose Coupling												Hose Coupling													
	Solids Passage mm	8.5							12					12	20			8.5							10		
	Impeller	Semi-open												Semi-open													
		High-chromium Cast Iron												High-chromium Cast Iron													
	Suction Cover	Ductile Cast Iron												Ductile Cast Iron													
	Oil Seal	Nitrile Butadiene Rubber								—				—			Nitrile Butadiene Rubber										
	Labyrinth Ring	—								304 Stainless Steel					304 Stainless Steel			—									
	Casing	Gray Cast Iron												Gray Cast Iron													
	Shaft Seal	Dual Inside Mechanical Seals (with Oil Lifter)												Dual Inside Mechanical Seals (with Oil Lifter)													
Silicon Carbide												Silicon Carbide															
Agitator	—												—														Ductile Cast Iron
MOTOR	Type	Continuous-duty Rated, Dry-type Induction Motor												Continuous-duty Rated, Dry-type Induction Motor													
	Output kW	1.5	2.2	3.7	1.5	2.2	3.7	5.5	3.7	5.5	7.5	11		15	7.5	11	15	1.5	2.2	3.7	1.5	2.2	3.7	2	3		
	Phase	Three												Three													
	Pole	2												2													
	Insulation	F												F													
	Starting Method	D.O.L.						D.O.L.*2	D.O.L.	D.O.L.*2					D.O.L.*2			D.O.L.									
	Motor Protector (built-in)	CTP												CTP													
	Lubricant ml	740	1250	740	1250	1100	1250	1100	760		820	760	820	740	1250	740	1250	740	1250	740	1250	740	1250				
		Turbine Oil (ISO VG32)												Turbine Oil (ISO VG32)													
	Frame	Gray Cast Iron												Gray Cast Iron													
Shaft	420 Stainless Steel												420 Stainless Steel														
Cable m	8												8														
	PVC	Chloroprene Rubber	PVC	Chloroprene Rubber									Chloroprene Rubber			PVC	Chloroprene Rubber	PVC	Chloroprene Rubber			PVC	Chloroprene Rubber				
Automatic Control Device	—												—			Electrode									—		
Dry Weight** kg	34	35	60	33	34	60	74	60	74	101	133		146	100	133	147	39	41	69	38	40	69	38	65			

\*\* Weights excluding cable    \*\* Star-Delta available upon request





We reserve the right to change the specifications and designs for improvement without prior notice.

**TSURUMI  
MANUFACTURING CO., LTD.**

Your Dealer