



TECHNICAL CHARACTERISTICS

- Aluminium alloy construction
- Smooth operation
- High efficiency impeller
- Maintenance free
- Mountable in any position

OPTIONS

- Special voltages (IEC 38)
- Surface treatments

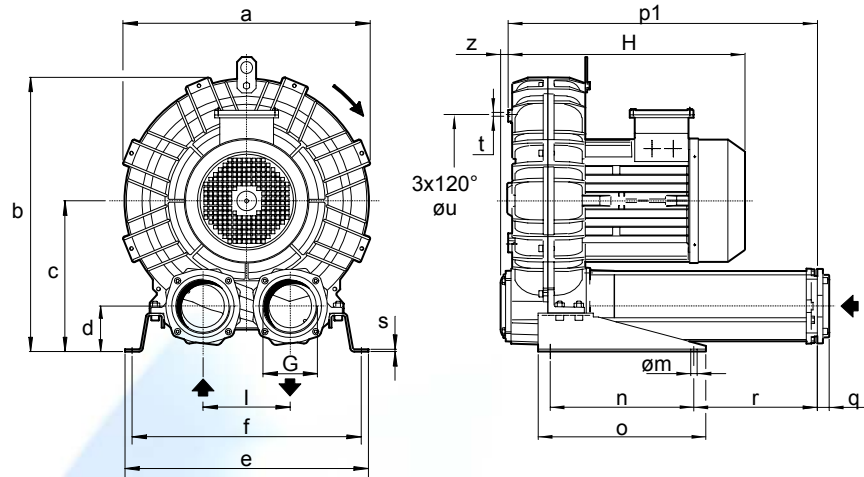

Dimensions in mm.
 Dimensions for reference only.

Model	a	b	c	d	e	f	G	l	m	n	o	p1	q	r	s	t	u	z
K07R-MD	424	481	269	82	468	438	G 2"	155	13	300	350	418	18	43	5	M8	295	16
K08R-MD	457	498	269	82	478	448	G 2"	155	13	300	350	418	18	43	5	M8	310	16
K09-MD	492	561	315	96	508	478	G 4"	182	13	300	350	644	25	257	5	M8	360	16
K10-MD	516	573	315	96	508	478	G 4"	182	13	300	350	644	25	257	5	M8	360	16
K11-MD	542	603	332	91	538	508	G 4"	200	13	300	350	654	25	262	5	M8	390	16
K12-MD	548	606	332	91	538	508	G 4"	200	13	300	350	657	25	262	5	M8	390	13

Model	Maximum flow m³/h		Installed power kW		Maximum differential pressure Δp hPa (mbar)		Noise Level Lp dB (A) (1)		Overall dimensions H mm	Weight Kg
	50 Hz 2900 rpm	60 Hz 3500 rpm	50 Hz 2900 rpm	60 Hz 3500 rpm	50 Hz 2900 rpm	60 Hz 3500 rpm	50 Hz 2900 rpm	60 Hz 3500 rpm		
K07R-MD	181	219	2.2	2.55	275	215	70.5	72.5	410	46.0
			3.0	3.45	400	335	71.0	73.0	410	47.0
			4.0	4.6	450	450	71.5	73.5	410	50.5
K08R-MD	236	285	3.0	3.45	250	180	73.4	75.4	410	49.5
			4.0	4.6	375	300	73.7	75.7	410	53.0
			5.5	6.3	450	450	74.1	76.1	445	63.5
K09-MD	311	375	4.0	4.6	285	200	74.4	76.4	420	65.5
			5.5	6.3	425	350	75.5	77.5	455	76.0
			7.5	8.7	475	475	77.0	79.0	455	81.0
K10-MD	387	467	5.5	6.3	340	260	78.4	80.4	455	77.5
			7.5	8.7	500	425	78.7	80.7	455	82.5
			-	10.6	-	500	-	81.0	490	92.0
K11-MD	431	520	5.5	6.3	250	175	78.4	80.4	460	91.0
			7.5	8.7	400	320	78.7	80.7	460	96.0
			9.2	10.6	500	425	79.0	81.0	495	105.5
			-	12.7	-	500	-	81.3	495	106.0
K12-MD	473	570	7.5	-	225	-	79.6	-	463	99.5
			9.2	10.6	350	200	79.9	81.9	498	109.0
			11.0	12.7	450	300	80.2	82.2	498	109.5
			-	17.4	-	450	-	82.5	498	111.5

(1) Noise measured at 1 m distance with inlet and outlet ports piped, in accordance to ISO 3744.

- For proper use, the blower should be equipped with inlet filter and safety valve; other accessories available on request.
- Ambient temperature from -15° to +40°C.
- Specifications subject to change without notice.



LATERAL CHANNEL BLOWERS - EXHAUSTERS SCL K07R / K08R / K09 / K10 / K11 / K12

MD SERIE - MOR RANGE

SN 1849-7 2/2

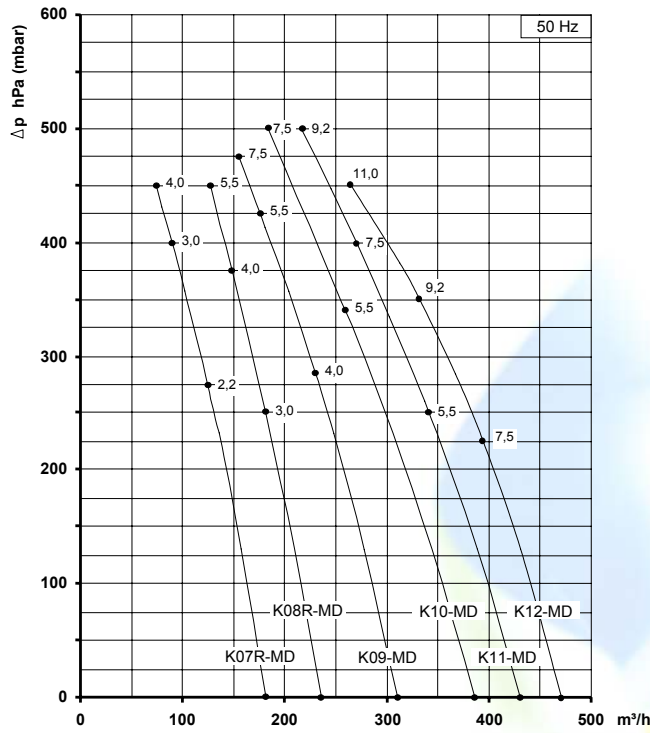

CAPACITY

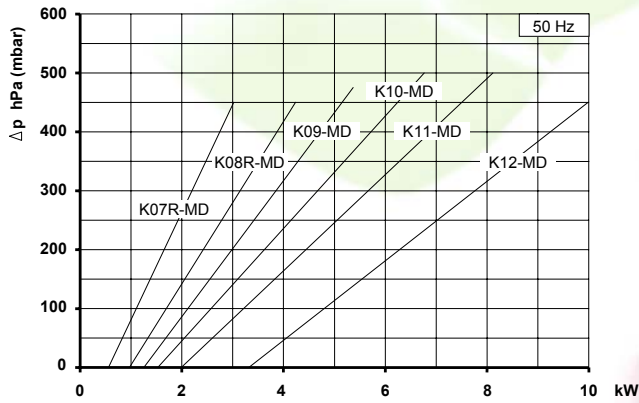
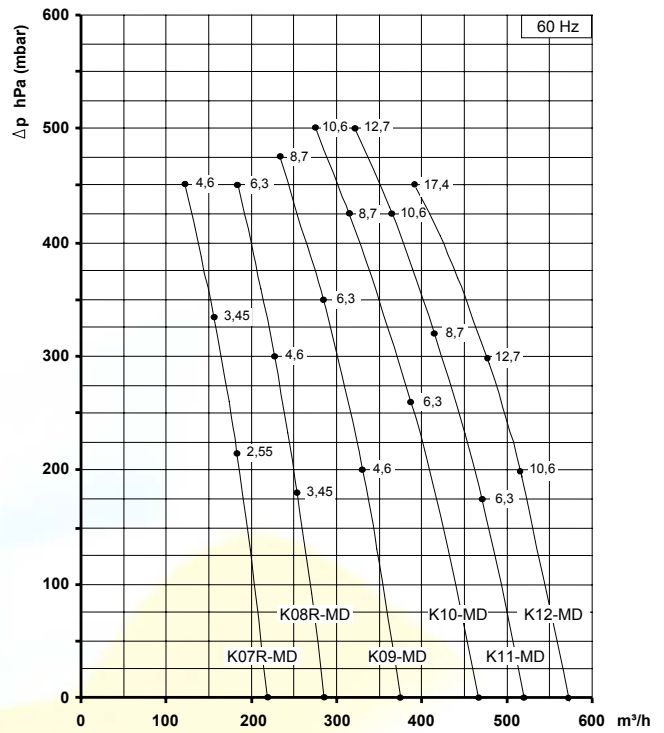

ABSORBED POWER

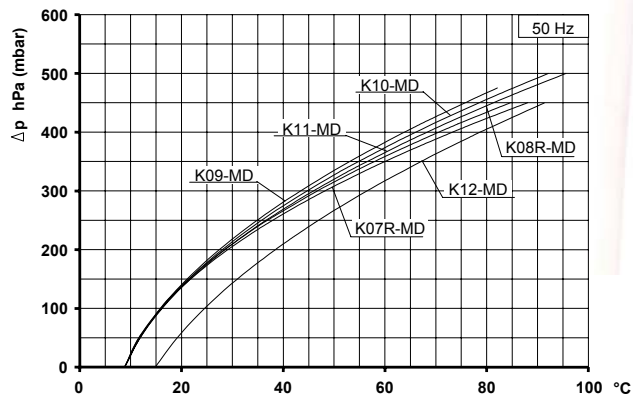
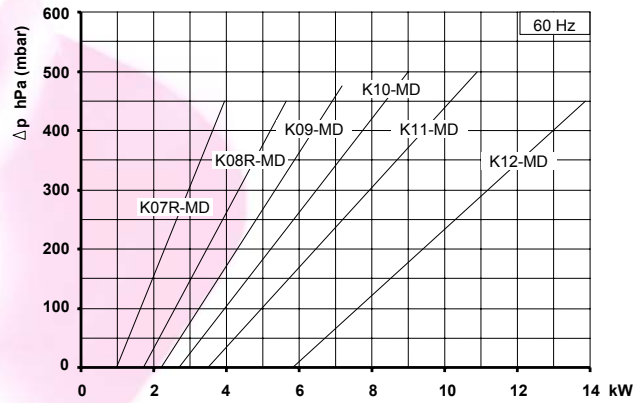

TEMPERATURE INCREASE

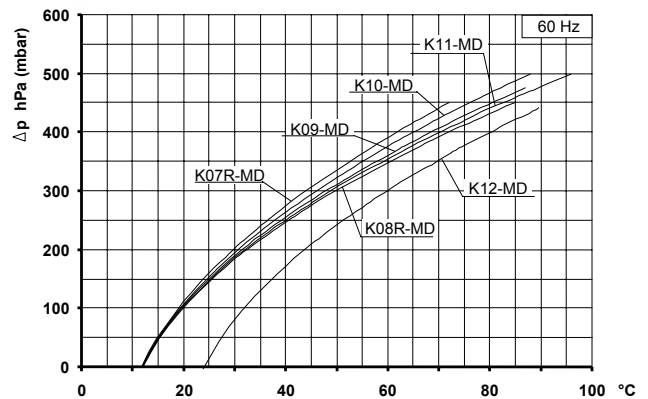

Curves refer to air at 20°C temperature, measured at inlet port and 1013 mbar (abs) atmospheric backpressure.
Tolerance on given values ±10%.
Data can change without prior notice.