

ACDE

Self Priming Centrifugal Pump

Models 11 1/2A2-B, 11 1/2A3-B, 11 1/2A20-B and 11 1/2A52-B

Size 1 1/2" x 1 1/2"



PUMP SPECIFICATIONS

Size: 1-1/2" x 1-1/2" (38 mm x 38 mm) NPT - Female.

Casing: Gray Iron 30.

Maximum Operating Pressure 63 psi (434 kPa).*

Semi-Open Type, Two Vane Impeller: Gray Iron 30.

Handles 1" (25,4 mm) Diameter Spherical Solids.

Impeller Shaft: Carbon Steel 1215.

Seal Liner: (11-1/2A2-B) Copper Alloy C26000.

Shaft Sleeve: (11-1/2A3-B, 11-1/2A20-B and 11-1/2A52-B)
Stainless Steel 304.

Replaceable Wear Plate: Carbon Steel 1026.

Removable Cover Plate: Gray Iron 30. Weight 5 lbs. (2,3 kg).

Pedestal: Gray Iron 30.

Seal Plate: Gray Iron 30.

Flap Valve: Steel, Gray Iron 30 and Buna-N w/Nylon Reinforcement.

Radial and Thrust Bearings: Open Single Row Ball.

Bearing Lubrication: Grease.

Flange: Gray Iron 30.

Gaskets: Cork w/Nitrile Binder and Vegetable Fiber.

Hardware: Standard Plated Steel.

Optional Equipment: Strainer.

Consult Factory for Additional Options.

**Consult Factory for Applications Exceeding
Maximum Pressure and/or Temperature Indicated.*



11 1/2A2-B SHOWN

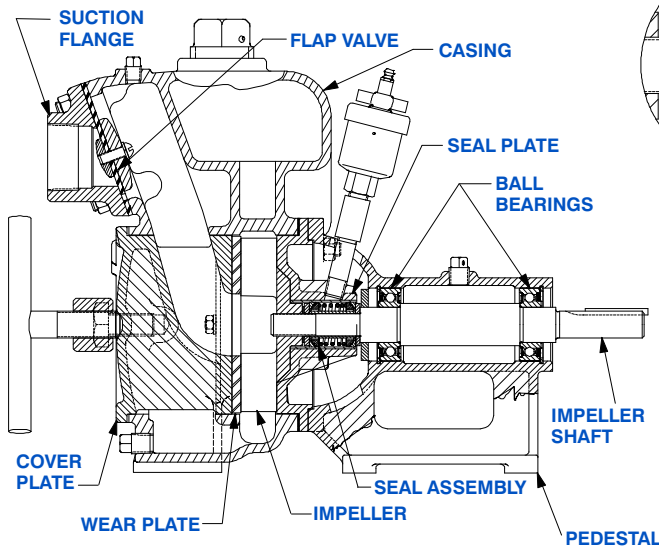

11 1/2A2-B SHOWN

11 1/2A2-B SEAL DETAIL

Double, Grease-Lubricated with Spring Loaded Grease Cup. Sintered Bronze Stationary Seal Seats. Steel Rotating Faces. Neoprene Packing Rings. Maximum Temperature of Liquid Pumped 110°F (43°C). Maximum Suction Pressure 10 PSI (69 kPa).*

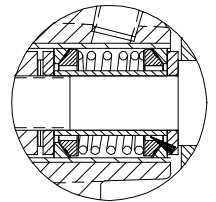

11 1/2A3-B SEAL DETAIL

Type 21, Mechanical, Self Lubricated. Carbon Rotating Face and Ceramic Stationary Face. Buna-N Elastomers. Stainless Steel 18-8 Cage and Spring. Maximum Temperature of Liquid Pumped, 160°F (71°C).*

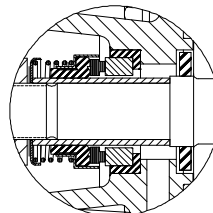

11 1/2A20-B SEAL DETAIL

Type 2, Mechanical, Oil Lubricated, Double Floating, Self-Aligning. Tungsten Titanium Carbide Rotating and Stationary Faces. Stainless Steel 316 Stationary Seat. Fluorocarbon Elastomers (DuPont Viton® or Equivalent). Stainless Steel 18-8 Cage and Spring. Maximum Temperature of Liquid Pumped 160°F (71°C).*

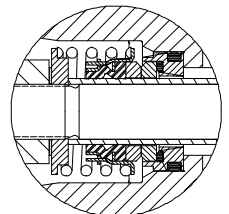

11 1/2A52-B SEAL DETAIL

Type 31, Mechanical, Self-Lubricated. Silicon Carbide Rotating and Stationary Faces. Fluorocarbon Elastomers (DuPont Viton® or Equivalent). Stainless Steel 316 Cage and Spring. Maximum Temperature of Liquid Pumped 160°F (71°C).*

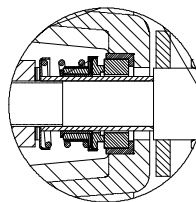

THE GORMAN-RUPP COMPANY • MANSFIELD, OHIO

GORMAN-RUPP OF CANADA LIMITED • ST. THOMAS, ONTARIO, CANADA

www.grpumps.com

Specifications Subject to Change Without Notice

Printed in U.S.A.

Specification Data

SECTION 55, PAGE 100

APPROXIMATE DIMENSIONS and WEIGHTS

	11 1/2A2, A3 and A52-B	11 1/2A20-B
NET WEIGHT:	59 LBS. (27 KG.)	65 LBS. (29 KG.)
SHIPPING WEIGHT:	69 LBS. (31 KG.)	72 LBS. (33 KG.)
EXPORT CRATE SIZE:	2.5 CU. FT. (0,07 CU. M.)	

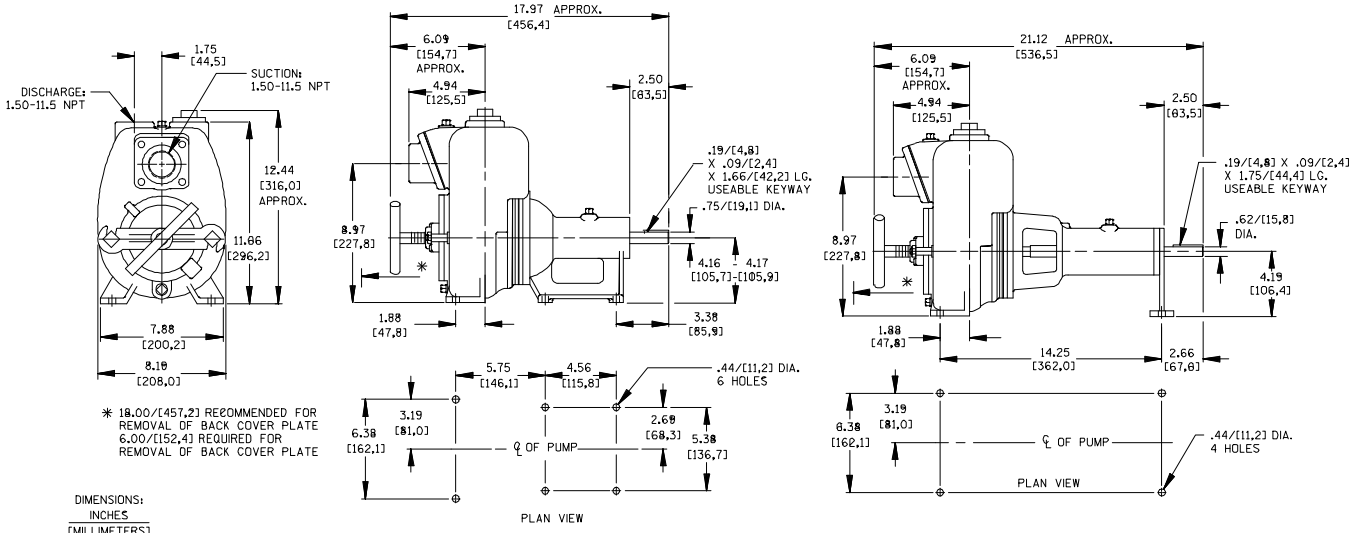

MODELS 11 1/2A2-B, 11 1/2A3-B and 11 1/2A52-B

MODEL 11 1/2A20-B

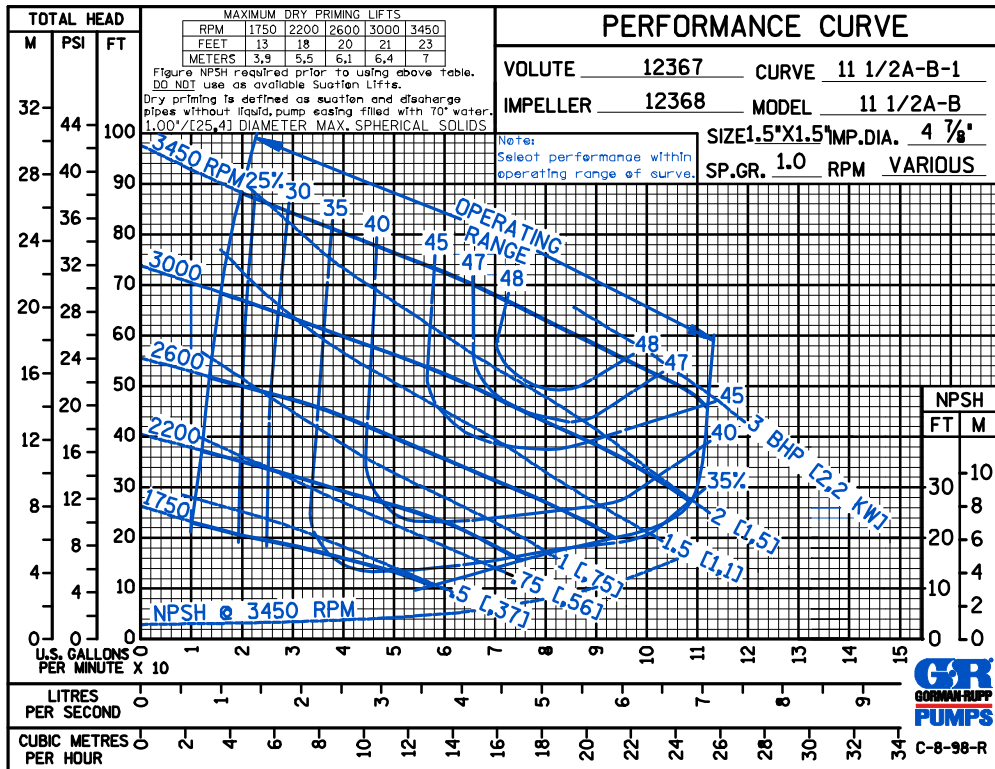

THE GORMAN-RUPP COMPANY • MANSFIELD, OHIO

GORMAN-RUPP OF CANADA LIMITED • ST. THOMAS, ONTARIO, CANADA

Specifications Subject to Change Without Notice

Printed in U.S.A.